



Digitized Automation for a Changing World

# Delta AC Servo Drive & Motor ASDA-A2 Series



## More Rapid, More Stable, More Precise

Delta Electronics, Inc., a leading manufacturer of industrial automation products, is pleased to announce the launch of its new high-performance ASDA-A2 series servo motors and servo drives with motion control.

The current trend for motion control has the control command source close to the drive. In response, Delta has developed the new ASDA-A2 series that offers excellent motion control so that the external controller is almost eliminated. The ASDA-A2 series features a built-in electronic cam (E-CAM) function which provides an excellent solution for flying shear, rotary cut and synchronized motion applications. The all new position register control PR mode is a unique and significant function that provides a variety of control modes to enhance system performance.

The ASDA-A2 series also supports various industrial communications protocols, such as CANopen, DMCNET, and EtherCAT which offers higher performance and high speed communications and enables the drive to integrate with other parts of the automation more efficiently and effectively. The full-closed loop control, auto notch filter, vibration suppression and gantry control functions help to perform complex motions that require high precision and smooth operation. The 20-bit superior resolution encoder which is essential for accurate positioning applications is equipped as standard. In addition, the outstanding Capture and Compare functions for high-speed pulses offer the best support for stepless positioning. Other additional functionality, such as up to 1kHz frequency response, innovative editing software, high-speed PC monitoring (similar to a digital oscilloscope), and more, all drastically maximize the performance of the ASDA-A2 series.

**Delta's new ASDA-A2 series is the ultimate servo system providing a total solution for a wide range of machine tools and industrial applications**



## Table of Contents

---

3	ASDA-A2 Series Features
9	Product Line-up
13	Model Explanation
14	Servo Motor Features
15	Servo Motor Specifications
21	Servo Motor Dimensions
29	Part Names and Functions
31	Wiring
39	ASDA-Soft Configuration Software
41	Optional Accessories
43	Servo Drive Specifications
45	Servo Drive Dimensions
51	Optional Cables and Connectors
61	Servo Drive, Servo Motor and Accessories Combinations
69	Safety Information
70	Regenerative Resistor Specifications

# ASDA-A2 Series Features

## High Positioning Accuracy

- ▶ ECMA series servo motors feature incremental encoders with 20-bit resolution which can eliminate unstable commands at low speed, smooth motor operation and enhance the accuracy of positioning.
- ▶ Absolute encoder supported. 17-bit motor position will not get lost when power is cut off.

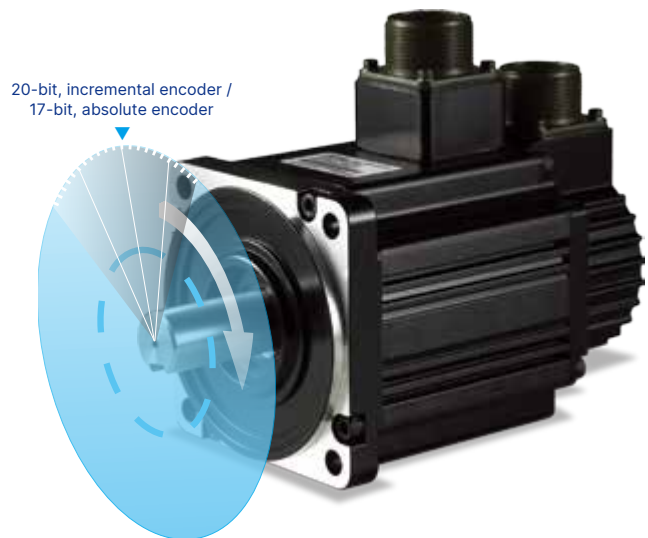

## High Responsiveness

- ▶ Up to 1kHz frequency response.
- ▶ Settling time below 1ms.
- ▶ 7ms acceleration time for speeds from -3,000 r/min to 3,000 r/min with an empty load!  
(Note: The test record of a 400W motor with 60mm frame size)

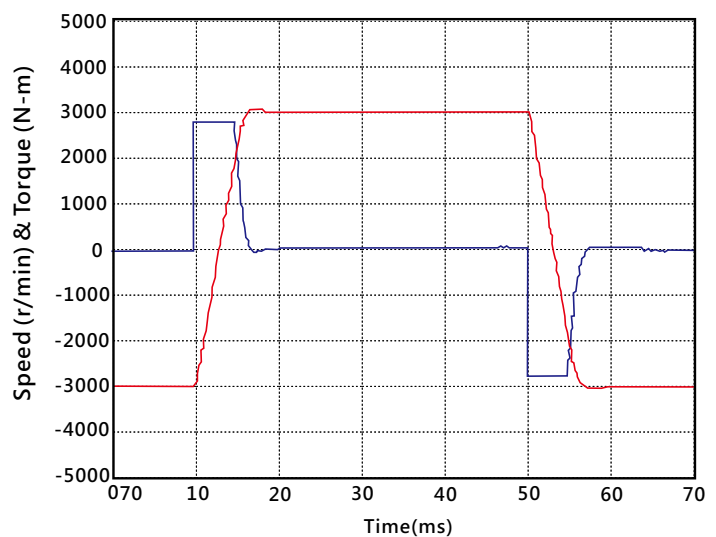
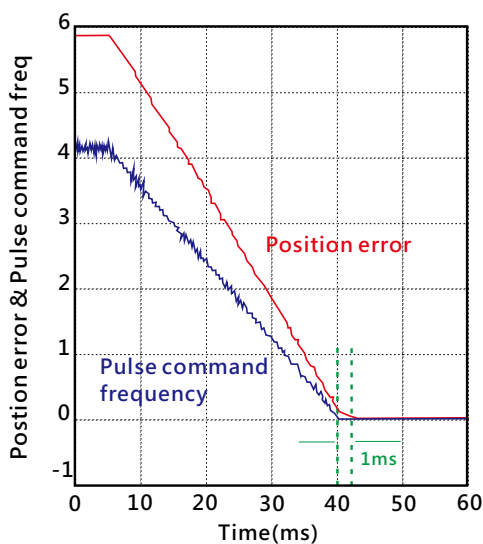

## Excellent Suppression Functions

### ▶ Vibration Suppression (Low Frequency)

Two vibration suppression filters are provided for long arm system to minimize the vibration at machine edges effectively.

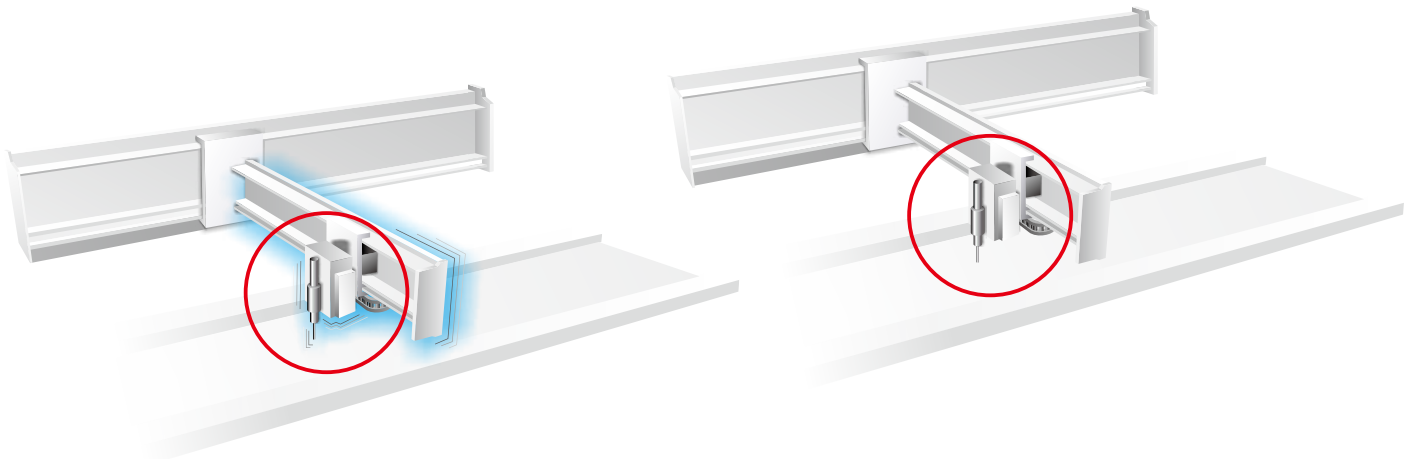

Without Suppression  
Function When Settling

With Suppression  
Function When Settling

### ▶ Resonance Suppression (High Frequency)

Two auto notch filters and one manual notch filter are provided to suppress mechanical resonance efficiently.

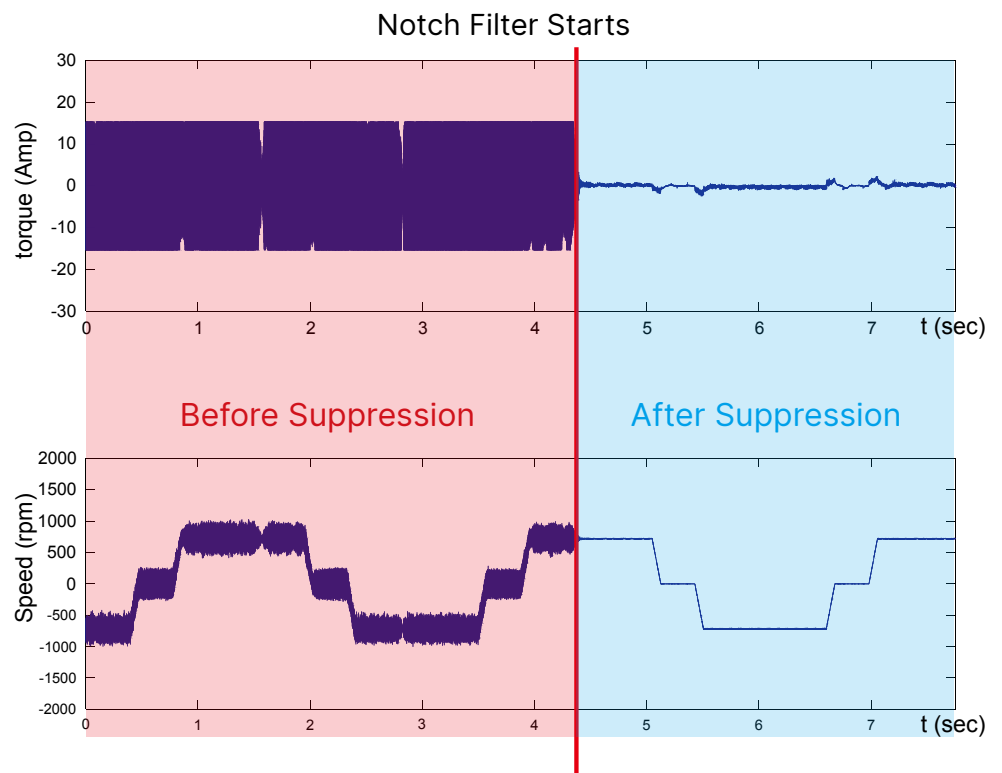

# ASDA-A2 Series Features

## Full-Closed Loop Control Function\*1

- ▶ Reduces the effects of backlash and flexibility from the machine and ensures the accuracy of positioning.

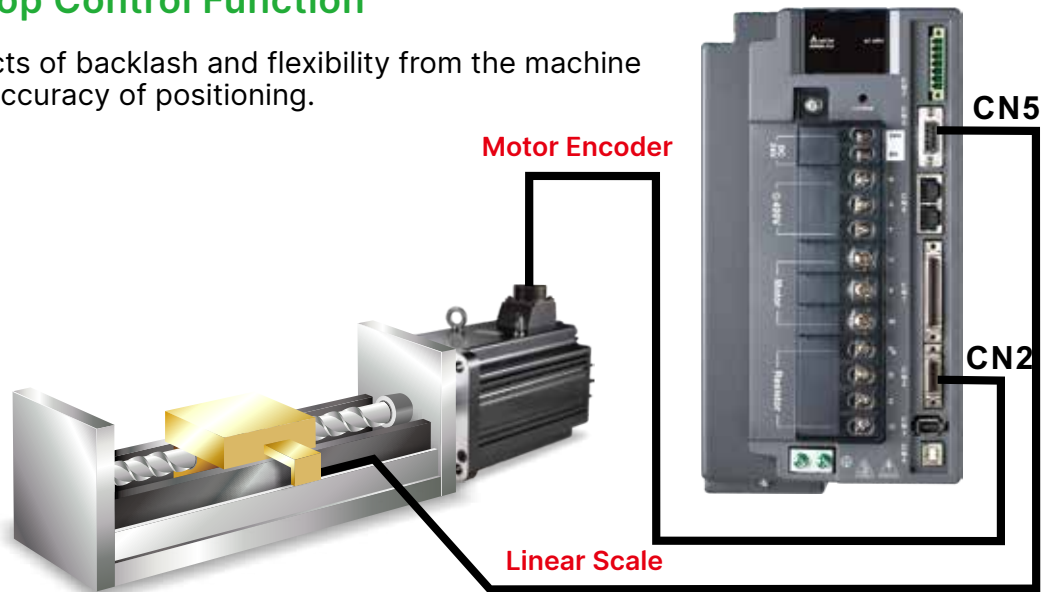

Note:  
\*1. PT and DMCNET mode only.

## Electronic CAM (E-CAM) Function

- ▶ 720 points max. for E-CAM outline.
- ▶ Smooth interpolation between points can be completed automatically to yield flexible programming.
- ▶ ASDA-Soft configuration software supported.
- ▶ Easy to use for flying shear, rotary cut, and other cam applications.



## Versatile PR Mode

- ▶ ASDA-Soft configuration software supported.
- ▶ New sub-modes supported, not traditional point-to-point control.
- ▶ 64 procedures can be applied.
- ▶ Motion profile can be changed instantaneously.
- ▶ 35 Homing modes / Jump mode / Write parameter mode / Constant speed mode / Position control mode supported.

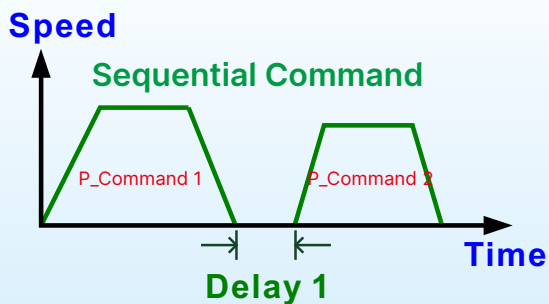

A command is executed only when the previous command is completed.

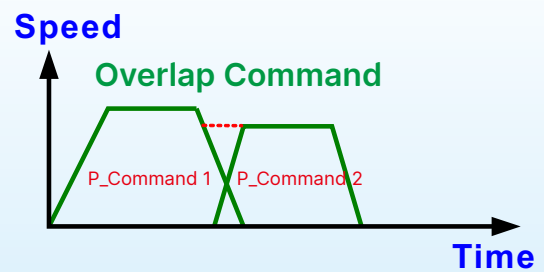

The second command is executed after the delay time or during the deceleration period.

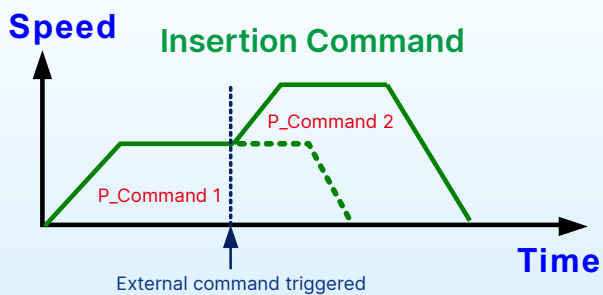

Insertion changes the command executed at the moment it is inserted.



# ASDA-A2 Series Features

## Capture and Compare Functions

### Capture - Position Latch Function

- ▶ Latches the coordinate value on the reference axis.
- ▶ Response time is less than 5us.
- ▶ Use for mark tracing.
- ▶ Maximum 800 records.

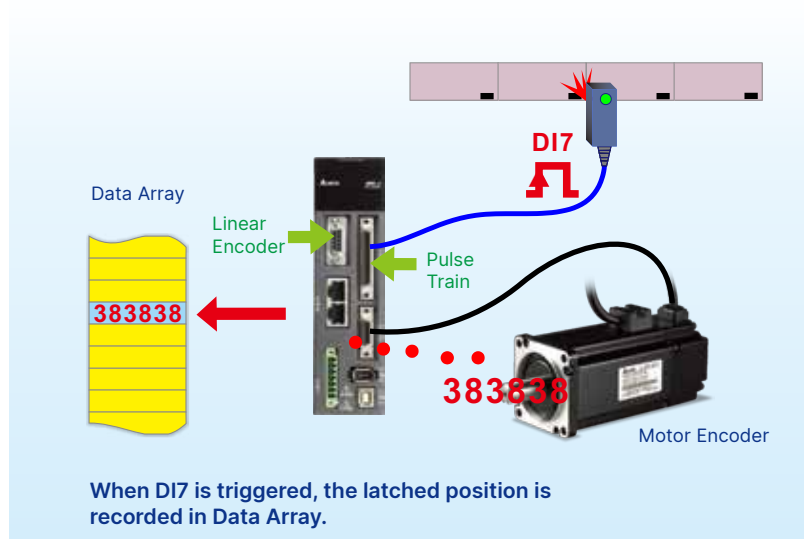

### Compare - Position Detection Function

- ▶ Detects the location on the reference axis.
- ▶ Response time is less than 5us.
- ▶ Use for CCD camera applications.
- ▶ Maximum 800 records.

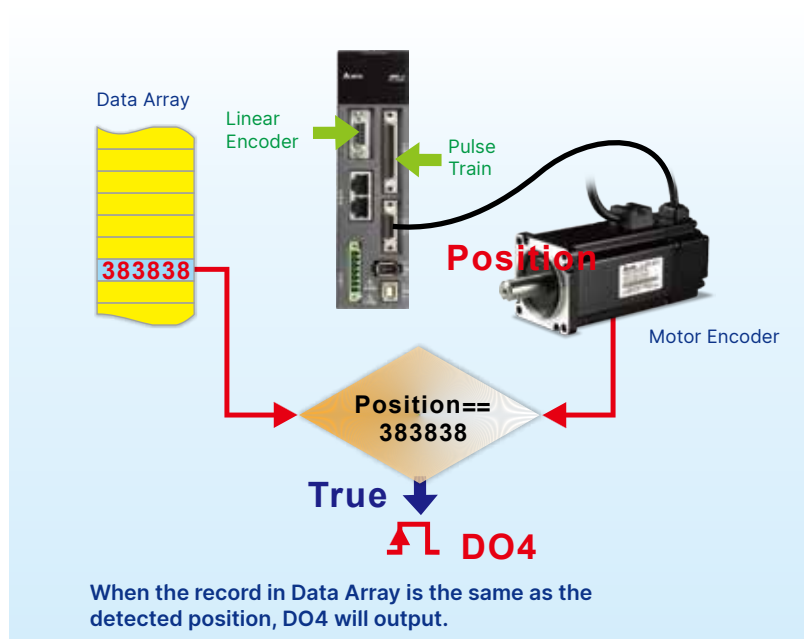



## Supports High-Speed DMCNET, EtherCAT, CANopen Protocols for Multi-Axis Synchronous Control

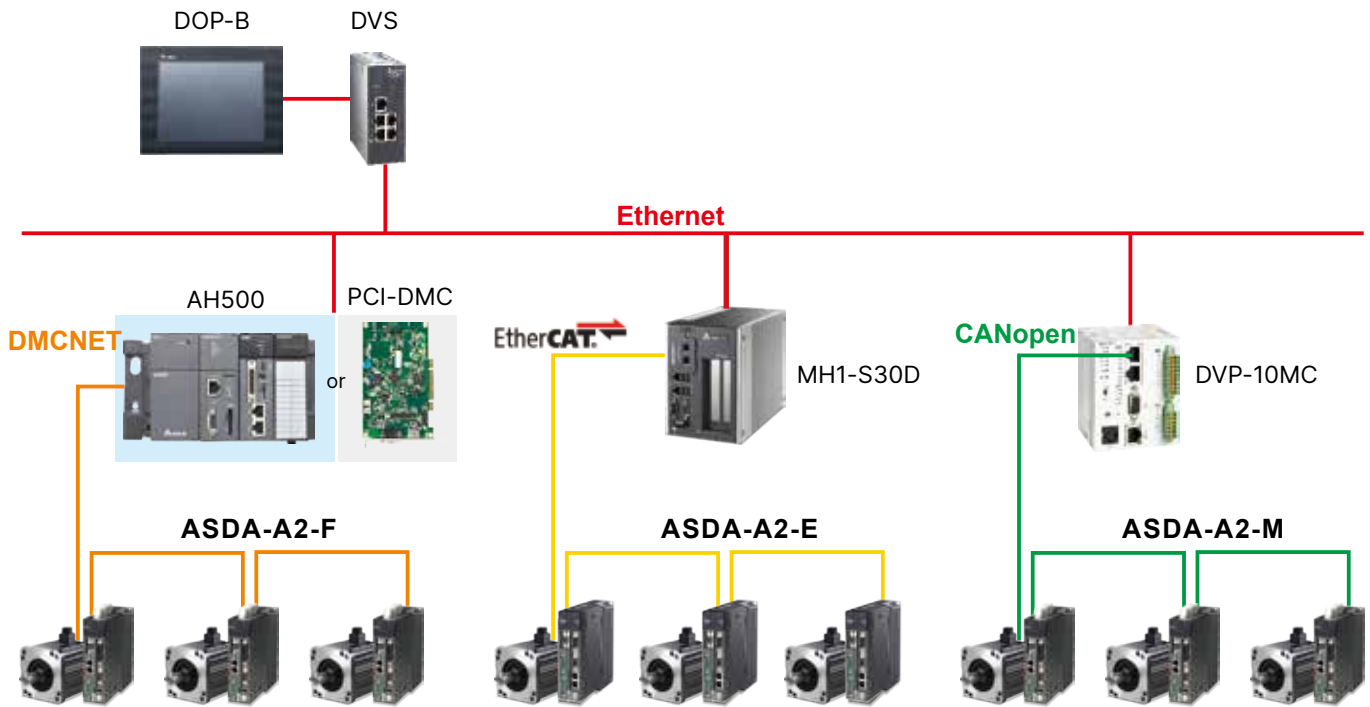

## Integrated Gantry Control

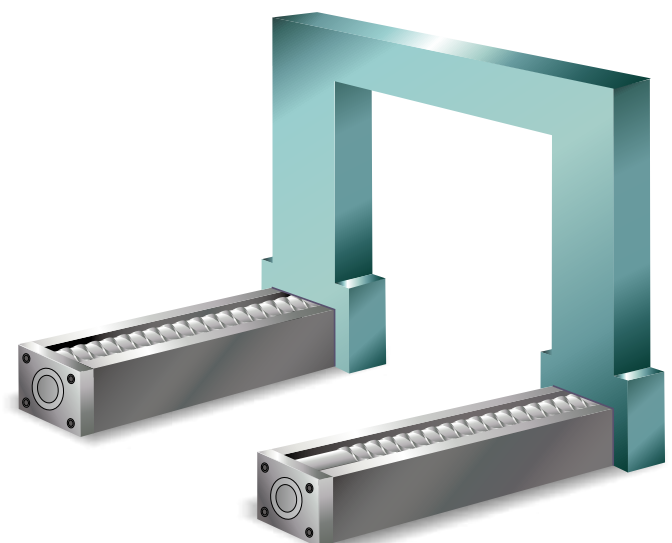
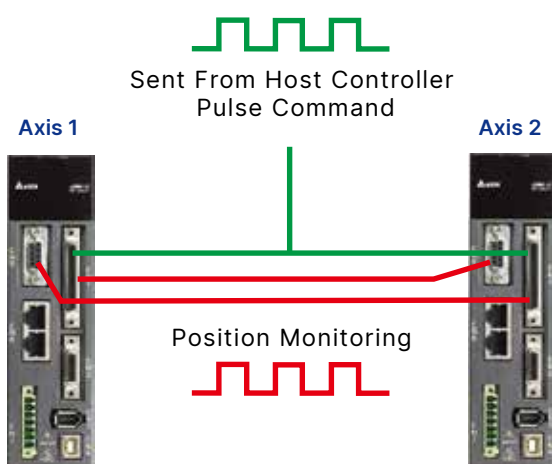

# Product Line-up

## 220 V Series

Servo Motors				
Motor Series		Phase	Rated Output Power (W)	Model Name
Low Inertia	ECMA-C 3,000 r/min	1-phase / 3-phase	50	ECMA-C1040F □ S
			100	ECMA-C △ 0401 □ S
			200	ECMA-C △ 0602 □ S
			400	ECMA-C △ 0604 □ S
			400	ECMA-C △ 0804 □ 7
			750	ECMA-C △ 0807 □ S
			750	ECMA-C △ 0907 □ S
			1,000	ECMA-C △ 0910 □ S
			1,000	ECMA-C △ 1010 □ S
			2,000	ECMA-C △ 1020 □ S
			3,000	ECMA-C △ 1330 □ 4
Medium Inertia	ECMA-E 2,000 r/min	1-phase / 3-phase	500	ECMA-E △ 1305 □ S
			1,000	ECMA-E △ 1310 □ S
			1,500	ECMA-E △ 1315 □ S
			2,000	ECMA-E △ 1320 □ S
			2,000	ECMA-E △ 1820 □ S
			3,000	ECMA-E △ 1830 □ S
			3,500	ECMA-E △ 1835 □ S
Medium-High Inertia	ECMA-F 1,500 r/min	1-phase / 3-phase	500	ECMA-F △ 1305 □ S
			850	ECMA-F △ 1308 □ S
			1,300	ECMA-F △ 1313 □ S
			1,800	ECMA-F △ 1318 □ S
			3,000	ECMA-F △ 1830 □ S
			4,500	ECMA-F △ 1845 □ S
			5,500	ECMA-F △ 1855 □ 3
			7,500	ECMA-F △ 1875 □ 3
			11,000	ECMA-F1221B □ 3
			15,000	ECMA-F1221F □ S
High Inertia	ECMA-C/G 3,000 r/min	1-phase / 3-phase	400	ECMA-C △ 0604 □ H
			750	ECMA-C △ 0807 □ H
			300	ECMA-G △ 1303 □ S
			600	ECMA-G △ 1306 □ S
			900	ECMA-G △ 1309 □ S



- 1) The boxes ( □ ) at the ends of the servo drive model names are for optional configurations. For the actual model name, please refer to the model explanation.
- 2) The boxes ( △ ) in the model names represent encoder type. △ =1: Incremental encoder, 20-bit; △ =2: Incremental encoder, 17-bit; △ =A: Absolute type.
- 3) The boxes ( □ ) in the model names represent shaft end/brake or the number of oil seal.

		Servo Drives		
Rated Current (Arms)	Maximum Current (A)	Model Name	Continuous Output Current (Arms)	Max. Instantaneous Current (A)
0.69	2.05	ASD-A2-0121- □	0.90	2.70
0.90	2.70			
1.55	4.65	ASD-A2-0221- □	1.55	4.65
2.60	7.80	ASD-A2-0421- □	2.60	7.80
2.60	7.80			
5.10	15.30	ASD-A2-0721- □	5.10	15.30
3.66	11.00			
4.25	12.37	ASD-A2-1021- □	7.30	21.90
7.30	21.90			
12.05	36.15	ASD-A2-2023- □	13.40	40.20
17.2	47.5	ASD-A2-3023- □	19.40	58.20
2.90	8.70	ASD-A2-0421- □	2.60	7.80
		ASD-A2-0721- □	5.10	15.30
5.60	16.80	ASD-A2-1021- □	7.30	21.90
8.30	24.90	ASD-A2-1521- □	8.66	24.90
11.01	33.03	ASD-A2-2023- □	13.40	40.20
11.22	33.66			
16.10	48.30	ASD-A2-3023- □	19.40	58.20
19.20	57.60			
3.90	12.10	ASD-A2-0721- □	5.10	15.30
7.10	19.40	ASD-A2-1021- □	7.30	21.90
12.60	38.60	ASD-A2-2023- □	13.40	40.20
13.00	36.00			
19.40	58.20	ASD-A2-3023- □	19.40	58.20
32.50	81.30	ASD-A2-4523- □	32.50	70.7
		ASD-A2-5523- □	40.00	106
40.00	100.00	ASD-A2-5523- □	40.00	106
47.50	118.80	ASD-A2-7523- □	47.50	141.1
51.80	129.50	ASD-A2-1B23- □	54.40	141.1
67	162	ASD-A2-1F23- □	70.00	212.2
2.60	7.80	ASD-A2-0421 □	2.60	7.80
5.10	15.30	ASD-A2-0721- □	5.10	15.30
2.50	7.50	ASD-A2-0421- □	2.60	7.80
4.80	14.40	ASD-A2-0721- □	5.10	15.30
7.50	22.50	ASD-A2-1021- □	7.30	21.90

ation of the servo drive.  
ype

# Product Line-up

## 400 V Series

Servo Motors				
Motor Series		Phase	Rated Output Power (W)	Model Name
Low Inertia	ECMA-J 3,000 r/min	3-phase	400	ECMA-J △ 0604 □ S
			750	ECMA-J △ 0807 □ S
			750	ECMA-J △ 0907 □ S
			1,000	ECMA-J △ 0910 □ S
			1,000	ECMA-J △ 1010 □ S
			2,000	ECMA-J △ 1020 □ S
			3,000	ECMA-J △ 1330 □ 4
Medium Inertia	ECMA-K 2,000 r/min	3-phase	750	ECMA-K △ 1305 □ S
			1,000	ECMA-K △ 1310 □ S
			1,500	ECMA-K △ 1315 □ S
			2,000	ECMA-K △ 1320 □ S
			2,000	ECMA-K △ 1820 □ S
Medium-High Inertia	ECMA-L 1,500 r/min	3-phase	750	ECMA-L △ 1305 □ S
			850	ECMA-L △ 1308 □ S
			1,300	ECMA-L △ 1313 □ S
			3,000	ECMA-L △ 1830 □ S
			4,500	ECMA-L △ 1845 □ S
			5,500	ECMA-L △ 1855 □ 3
			7,500	ECMA-L △ 1875 □ 3
			11,000	ECMA-L1221B □ 3
			15,000	ECMA-L1221F □ 3
High Inertia	ECMA-M 3,000 r/min	3-phase	900	ECMA-M △ 1309 □ S



- 1) The boxes ( □ ) at the ends of the servo drive model names are for optional configurations. For the actual model name, please refer to the model name.
- 2) The boxes ( △ ) in the model names represent encoder type. △ =1: Incremental encoder, 20-bit ; △ =2: Incremental encoder, 17-bit; △ =A: Absolute encoder.
- 3) The boxes ( □ ) in the model names represent shaft end/brake or the number of oil seal.

		Servo Drives		
Rated Current (Arms)	Maximum Current (A)	Model Name	Continuous Output Current (Arms)	Max. Instantaneous Current (A)
1.62	4.85	ASD-A2-0743-□	3.07	9.21
3.07	9.5	ASD-A2-0743-□	3.07	9.21
		ASD-A2-1043-□	3.52	9.86
2.16	6.37	ASD-A2-0743-□	3.07	9.21
2.4	7.17	ASD-A2-1043-□	3.52	9.86
4.15	12.46	ASD-A2-1543-□	5.02	10.04
		ASD-A2-2043-□	6.66	18.65
7.09	21.28	ASD-A2-2043-□	6.66	18.65
		ASD-A2-3043-□	11.9	33.2
9.8	29.99	ASD-A2-3043-□	11.9	33.32
1.7	5.2	ASD-A2-0743-□	3.07	9.21
3.52	10.56	ASD-A2-1043-□	3.52	9.86
		ASD-A2-1543-□	5.02	10.04
		ASD-A2-2043-□	6.66	18.65
5.02	15.06	ASD-A2-1543-□	5.02	10.04
		ASD-A2-2043-□	6.66	18.65
6.66	19.98	ASD-A2-2043-□	6.66	18.65
		ASD-A2-3043-□	11.9	33.32
6.6	19.88	ASD-A2-2043-□	6.66	18.65
		ASD-A2-3043-□	11.9	33.32
2.1	6.1	ASD-A2-0743-□	3.07	9.21
3.4	8.85	ASD-A2-1043-□	3.52	9.86
5.02	15	ASD-A2-1543-□	5.02	10.04
		ASD-A2-2043-□	6.66	18.65
11.53	34.6	ASD-A2-3043-□	11.9	33.32
		ASD-A2-4543-□	20	44
20.8	52	ASD-A2-4543-□	20	44
		ASD-A2-5543-□	22.04	48.49
		ASD-A2-7543-□	28.39	62.46
22.37	56	ASD-A2-5543-□	22.04	48.49
		ASD-A2-7543-□	28.39	62.46
27.3	68.3	ASD-A2-7543-□	28.39	62.46
		ASD-A2-1B43-□	28.1	61.82
		ASD-A2-1F43-□	38.65	85.03
27.2	68	ASD-A2-1B43-□	28.1	61.82
		ASD-A2-1F43-□	38.65	85.03
41.6	100	ASD-A2-1F43-□	38.65	85.03
4.4	13.1	ASD-A2-1543-□	5.02	10.04

Explanation of the servo drive.  
 te type

# Model Explanation

## ASDA-A2 Series Servo Drives

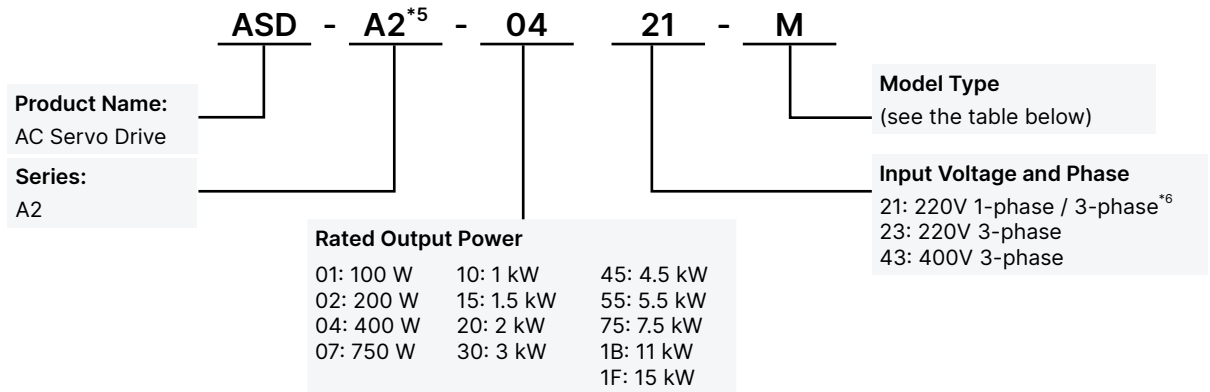

	Type	RS-485 (CN3)	Full-Closed Control (CN5) <sup>*1</sup>	Extension Port for Digital Input (CN7)	EtherCAT <sup>*4</sup>	CANopen	DMCNET	Analog Voltage Control	Pulse Input Port	PR Parameters	E-CAM <sup>*3</sup>
Standard Model	L	○	○	X	X	X	X	○	○	○	X
	U	○	○	○	X	X	X	○	○	○	○
Network Model	E	X	X	○	○	X	X	X	X	○	X
	F	○	○	X	X	X	○	X	X	○ <sup>*2</sup>	X
	M	○	○	X	X	○	X	○	○	○	○



**NOTE**

- In PR mode, only A2-F supports full-closed control function.
- When applying communication mode (A2-E, -F, -M models), PR parameters can be read and written through DMCNET only.
- E-CAM function can only be used in PR mode.
- For information about ASDA A2-E EtherCAT interface servo drive, please refer to the ASDA A2-E brochure.
- For communication mode -F/-M models with 400V/11kW, 15kW is categorized as ASDA-A2R.
- Rated power of 100W to 1.5kW are marked number 21 with 220V, single-phase and three-phase connections.

## ECMA Series Servo Motors

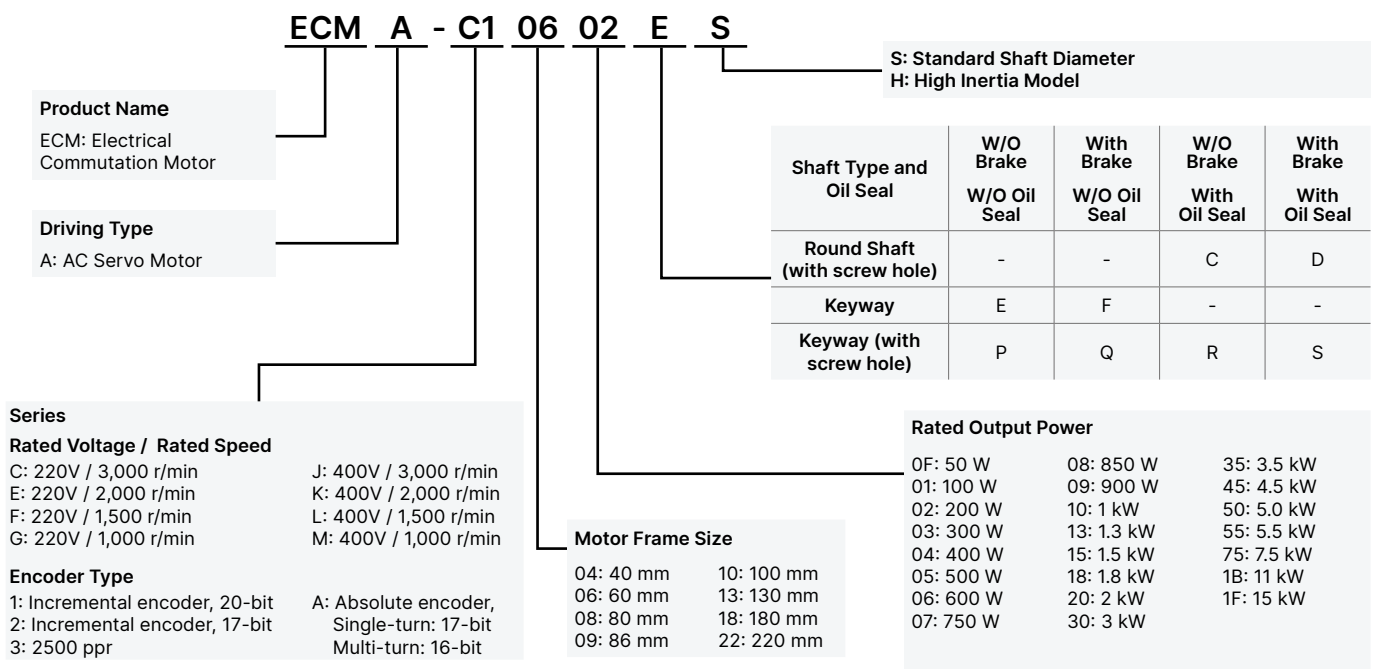

## Servo Motor Features

**ECMA** series servo motors are permanent AC servo motors, capable of combining with 200 to 230V ASDA-A2 220V series AC servo drives from 50 W to 15 kW and 380V to 480V ASDA-A2 400V series AC servo drives from 750 W to 7.5 kW.

For the 220V series, there are 40 mm, 60 mm, 80 mm, 86 mm, 100 mm, 130 mm, 180 mm, and 200 mm eight kinds of frame sizes available. The motor speed is from 1,000 r/min to 5,000 r/min and the torque output is from 0.477 N-m to 224 N-m.

For the 400V series, there are 60 mm, 80 mm, 86 mm, 100 mm, 130 mm, 180 mm, six kinds of frame sizes available. The motor speed is from 1,500 r/min to 5,000 r/min and the torque output is from 3.82 N-m to 119.36 N-m. In terms of optional configurations, ECMA series provides brake and oil seal to fully support our customers' needs. It also offers two different shaft selections, round shaft and keyway, for various applications.

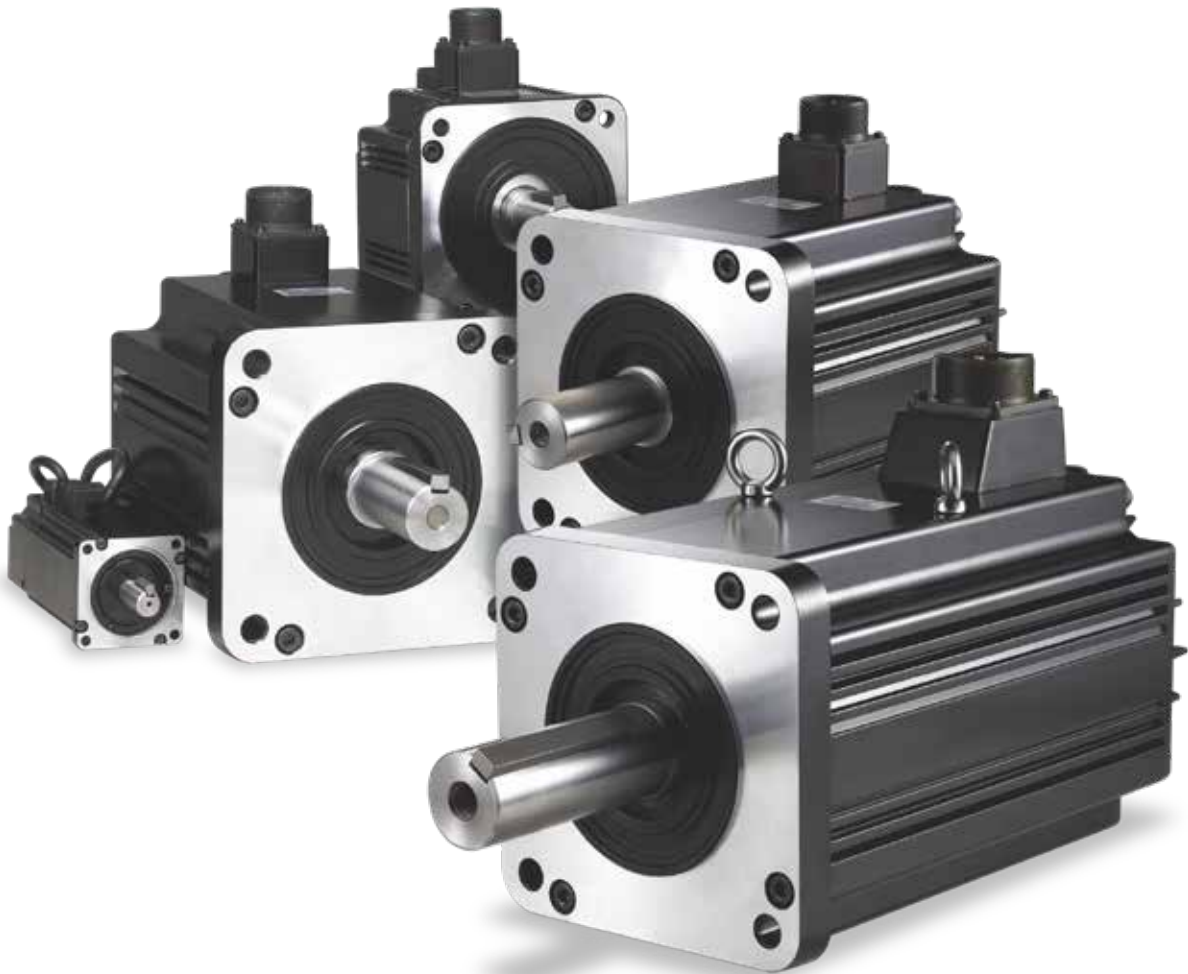

# Servo Motor Specifications

## Low Inertia Series- 220V Series

ECMA Series	C104	C Δ 04	C Δ 06		C Δ 08		C Δ 09		C Δ 10		C Δ 13
	0F	01	02	04 □ S	04	07	07	10	10	20	30
Rated output power (kW)	0.05	0.1	0.2	0.4	0.4	0.75	0.75	1.0	1.0	2.0	3.0
Rated torque (N-m) <sup>*1</sup>	0.159	0.32	0.64	1.27	1.27	2.39	2.39	3.18	3.18	6.37	9.55
Maximum torque (N-m)	0.477	0.96	1.92	3.82	3.82	7.16	7.14	8.78	9.54	19.11	28.65
Rated speed (r/min)	3,000						3,000		3,000		3,000
Maximum speed (r/min)	5,000						3,000		5,000		4,500
Rated current (A)	0.69	0.90	1.55	2.6	2.6	5.1	3.66	4.25	7.3	12.05	17.2
Maximum current (A)	2.05	2.70	4.65	7.8	7.8	15.3	11	12.37	21.9	36.15	47.5
Power rating (kW/s)	12.27	27.7	22.4	57.6	24.0	50.4	29.6	38.6	38.1	90.6	71.8
Rotor moment of inertia (x10 <sup>-4</sup> kg-m <sup>2</sup> )	0.0206	0.037	0.177	0.277	0.68	1.13	1.93	2.62	2.65	4.45	12.7
Mechanical time constant (ms)	1.2	0.75	0.80	0.53	0.74	0.63	1.72	1.20	0.74	0.61	1.11
Torque constant-KT (N-m/A)	0.23	0.36	0.41	0.49	0.49	0.47	0.65	0.75	0.44	0.53	0.557
Voltage constant-KE (mV/(r/min))	9.8	13.6	16	17.4	18.5	17.2	24.2	27.5	16.8	19.2	20.98
Armature resistance (Ohm)	12.7	9.30	2.79	1.55	0.93	0.42	1.34	0.897	0.20	0.13	0.0976
Armature inductance (mH)	26	24.0	12.07	6.71	7.39	3.53	7.55	5.7	1.81	1.50	1.21
Electrical time constant (ms)	2.05	2.58	4.3	4.3	7.96	8.36	5.66	6.35	9.3	11.4	12.4
Insulation class	Class A (UL), Class B (CE)										
Insulation resistance	100M Ω , DC 500 V above										
Insulation strength	1.8k Vac,1 sec										
Weight (kg)(without brake)	0.42	0.5	1.2	1.6	2.1	3.0	2.9	3.8	4.3	6.2	7.8
Weight (kg)(with brake)	--	0.8	1.5	2.0	2.9	3.8	3.69	5.5	4.7	7.2	9.2
Max. radial shaft load (N)	78.4	78.4	196	196	245	245	245	245	490	490	490
Max. thrust shaft load (N)	39.2	39.2	68	68	98	98	98	98	98	98	98
Power rating (kW/s)(with brake)	--	25.6	21.3	53.8	22.1	48.4	29.3	37.9	30.4	82	65.1
Rotor moment of inertia (x10 <sup>-4</sup> kg-m <sup>2</sup> )(with brake)	--	0.04	0.19	0.30	0.73	1.18	1.95	2.67	3.33	4.95	14.0
Mechanical time constant (ms)(with brake)	--	0.81	0.85	0.57	0.78	0.65	1.74	1.22	0.93	0.66	1.22
Brake holding torque [Nt-m (min)] <sup>*2</sup>	--	0.3	1.3	1.3	2.5	2.5	2.5	2.5	8	8	10.0
Brake power consumption (at 20°C)[W]	--	7.3	6.5	6.5	8.2	8.2	8.2	8.2	18.7	18.7	19.0
Brake release time [ms (Max)]	--	5	10	10	10	10	10	10	10	10	10
Brake pull-in time [ms (Max)]	--	25	70	70	70	70	70	70	70	70	70
Vibration grade (μm)	15										
Operating temperature (°C)	0°C to 40°C										
Storage temperature (°C)	-10°C to 80°C										
Operating humidity	20 to 90%RH (non-condensing)										
Storage humidity	20 to 90%RH (non-condensing)										
Vibration capacity	2.5G										
IP Rating	IP65 (when waterproof connectors are used, or when an oil seal is used to be fitted to the rotating shaft (an oil seal model is used))										
Approvals											

\*1. Rate torque values are continuous permissible values at 0 ~ 40°C ambient temperature when attaching with the sizes of heatsinks listed below:  
 ECMA-- 04 / 06 / 08: 250 mm x 250 mm x 6 mm  
 ECMA-- 10: 300 mm x 300 mm x 12 mm  
 ECMA-- 13: 400 mm x 400 mm x 20 mm  
 ECMA-- 18: 550 mm x 550 mm x 30 mm  
 ECMA-- 22: 650 mm x 650 mm x 35 mm  
 Material type : Aluminum - F40, F60, F80, F100, F130, F180, F220

\*2. The holding brake is used to hold the motor shaft, not for braking the rotation. Never use it for decelerating or stopping the machine.



## Medium Series- 220 V Series

ECMA Series	E $\Delta$ 13				E $\Delta$ 18		
	05	10	15	20	20	30	35
Rated output power (kW)	0.5	1.0	1.5	2.0	2.0	3.0	3.5
Rated torque (N-m) <sup>*1</sup>	2.39	4.77	7.16	9.55	9.55	14.32	16.71
Maximum torque (N-m)	7.16	14.3	21.48	28.65	28.65	42.97	50.13
Rated speed (r/min)	2,000						
Maximum speed (r/min)	3,000						
Rated current (A)	2.9	5.6	8.3	11.01	11.22	16.1	19.2
Maximum current (A)	8.7	16.8	24.9	33.03	33.66	48.3	57.6
Power rating (kW/s)	7.0	27.1	45.9	62.5	26.3	37.3	50.8
Rotor moment of inertia (x10 <sup>-4</sup> kg-m <sup>2</sup> )(without brake)	8.17	8.41	11.18	14.59	34.68	54.95	54.95
Mechanical time constant (ms)	1.91	1.51	1.10	0.96	1.62	1.06	1.08
Torque constant-KT (N-m/A)	0.83	0.85	0.87	0.87	0.85	0.89	0.87
Voltage constant-KE (mV/(r/min))	30.9	31.9	31.8	31.8	31.4	32.0	32
Armature resistance (Ohm)	0.57	0.47	0.26	0.174	0.119	0.052	0.052
Armature inductance (mH)	7.39	5.99	4.01	2.76	2.84	1.38	1.38
Electrical time constant (ms)	12.96	12.88	15.31	15.86	23.87	26.39	26.39
Insulation class	Class A (UL), Class B (CE)						
Insulation resistance	100M $\Omega$ , DC 500V above						
Insulation strength	1.8k Vac,1 sec						
Weight (kg)(without brake)	6.8	7.0	7.5	7.8	13.5	18.5	18.5
Weight (kg)(with brake)	8.2	8.4	8.9	9.2	17.5	22.5	22.5
Max. radial shaft load (N)	490	490	490	490	1,176	1,470	1,470
Max. thrust shaft load (N)	98	98	98	98	490	490	490
Power rating (kW/s)(with brake)	6.4	24.9	43.1	57.4	24.1	35.9	48.9
Rotor moment of inertia (x10 <sup>-4</sup> kg-m <sup>2</sup> )(with brake)	8.94	9.14	11.90	15.88	37.86	57.06	57.06
Mechanical time constant (ms)(with brake)	2.07	1.64	1.19	1.05	1.77	1.10	1.12
Brake holding torque [Nt-m (min)] <sup>*2</sup>	10.0	10.0	10.0	10.0	25.0	25.0	25.0
Brake power consumption (at 20°C)[W]	19.0	19.0	19.0	19.0	20.4	20.4	20.4
Brake release time [ms (Max)]	10	10	10	10	10	10	10
Brake pull-in time [ms (Max)]	70	70	70	70	70	70	70
Vibration grade ( $\mu$ m)	15						
Operating temperature (°C)	0°C to 40°C						
Storage temperature (°C)	-10°C to 80°C						
Operating humidity	20 to 90%RH (non-condensing)						
Storage humidity	20 to 90%RH (non-condensing)						
Vibration capacity	2.5G						
IP Rating	IP65 (when waterproof connectors are used, or when an oil seal is used to be fitted to the rotating shaft (an oil seal model is used))						
Approvals							

\*1. Rate torque values are continuous permissible values at 0 ~ 40°C ambient temperature when attaching with the sizes of heatsinks listed below:

ECMA-\_\_ 04 / 06 / 08: 250 mm x 250 mm x 6 mm

ECMA-\_\_ 10: 300 mm x 300 mm x 12 mm

ECMA-\_\_ 13: 400 mm x 400 mm x 20 mm

ECMA-\_\_ 18: 550 mm x 550 mm x 30 mm

ECMA-\_\_ 22: 650 mm x 650 mm x 35 mm

Material type : Aluminum - F40, F60, F80, F100, F130, F180, F220

\*2. The holding brake is used to hold the motor shaft, not for braking the rotation. Never use it for decelerating or stopping the machine.

# Servo Motor Specifications

## Medium-High Inertia Series- 220V Series

ECMA Series	F $\Delta$ 13				F $\Delta$ 18				F122	
	05	08	13	18	30	45	55	75	1B	1F
Rated output power (kW)	0.5	0.85	1.3	1.8	3.0	4.5	5.5	7.5	11	15
Rated torque (N-m) <sup>*1</sup>	3.18	5.41	8.34	11.48	19.10	28.65	35.01	47.74	70	95.4
Maximum torque (N-m)	8.92	13.8	23.3	28.7	57.29	71.62	87.53	119.36	175	224.0
Rated speed (r/min)	1,500									
Maximum speed (r/min)	3,000								2,000	
Rated current (A)	3.9	7.1	12.6	13	19.4	32.5	40.0	47.5	51.8	67
Maximum current (A)	12.1	19.4	38.6	36	58.2	81.3	100.0	118.8	129.5	162
Power rating (kW/s)	9.8	21.52	34.78	52.93	66.4	105.5	122.9	159.7	144.9	201.8
Rotor moment of inertia (x10 <sup>-4</sup> kg-m <sup>2</sup> )(without brake)	10.3	13.6	20	24.9	54.95	77.75	99.78	142.7	338	451
Mechanical time constant (ms)	2.8	2.43	1.62	1.7	1.28	0.92	0.96	0.63	1.38	1.23
Torque constant-KT (N-m/A)	0.82	0.76	0.66	0.88	0.98	0.88	0.88	1.01	1.37	1.42
Voltage constant-KE (mV/(r/min))	29.5	29.2	24.2	32.2	35.0	32.0	31.0	35.5	49	50
Armature resistance (Ohm)	0.624	0.38	0.124	0.185	0.077	0.032	0.025	0.015	0.026	0.0184
Armature inductance (mH)	7	4.77	1.7	2.6	1.27	0.89	0.60	0.40	0.65	0.48
Electrical time constant (ms)	11.22	12.55	13.71	14.05	16.5	27.8	24.0	26.7	24.79	26.09
Insulation class	Class A (UL), Class B (CE)									
Insulation resistance	100M $\Omega$ , DC 500 V above									
Insulation strength	1.8k Vac,1 sec									
Weight (kg)(without brake)	6.3	8.6	9.4	10.5	18.5	23.5	30.5	40.5	56.4	75
Weight (kg)(with brake)	7.7	10.0	10.8	11.9	22.5	29	36	46	68.4	87
Max. radial shaft load (N)	490	490	490	490	1,470	1,470	1,764	1,764	3,300	3,300
Max. thrust shaft load (N)	98	98	98	98	490	490	588	588	1,100	1,100
Power rating (kW/s)(with brake)	8.8	19.78	32.66	50.3	63.9	101.8	119.4	156.6	141.4	197.1
Rotor moment of inertia (x10 <sup>-4</sup> kg-m <sup>2</sup> )(with brake)	11.5	14.8	21.3	26.2	57.06	80.65	102.70	145.55	346.5	461.8
Mechanical time constant (ms)(with brake)	3.12	2.65	1.73	1.79	1.33	0.96	0.99	0.64	1.41	1.25
Brake holding torque[Nt-m(min)] <sup>*2</sup>	10	10.0	10.0	10.0	25.0	55.0	55.0	55.0	115	115
Brake power consumption (at 20°C)[W]	19	19.0	19.0	19.0	20.4	19.9	19.9	19.9	28.8	28.8
Brake release time [ms (Max)]	10	10	10	10	10	10	10	10	10	10
Brake pull-in time [ms (Max)]	70	70	70	70	70	70	70	70	70	70
Vibration grade ( $\mu$ m)	15									
Operating temperature (°C)	0°C to 40°C									
Storage temperature (°C)	-10°C to 80°C									
Operating humidity	20 to 90%RH (non-condensing)									
Storage humidity	20 to 90%RH (non-condensing)									
Vibration capacity	2.5G									
IP Rating	IP65 (when waterproof connectors are used, or when an oil seal is used to be fitted to the rotating shaft (an oil seal model is used))									
Approvals										

\*1. Rate torque values are continuous permissible values at 0 ~ 40°C ambient temperature when attaching with the sizes of heatsinks listed below:

ECMA-\_\_ 04 / 06 / 08: 250 mm x 250 mm x 6 mm

ECMA-\_\_ 10: 300 mm x 300 mm x 12 mm

ECMA-\_\_ 13: 400 mm x 400 mm x 20 mm

ECMA-\_\_ 18: 550 mm x 550 mm x 30 mm

ECMA-\_\_ 22: 650 mm x 650 mm x 35 mm

Material type : Aluminum - F40, F60, F80, F100, F130, F180, F220

\*2. The holding brake is used to hold the motor shaft, not for braking the rotation. Never use it for decelerating or stopping the machine.

## High Inertia Series- 220 V Series

ECMA Series	C $\Delta$ 06		C $\Delta$ 08		G $\Delta$ 13	
	04 $\square$ H	07 $\square$ H	03	06	09	
Rated output power (kW)	0.4	0.75	0.3	0.6	0.9	
Rated torque (N-m) <sup>*1</sup>	1.27	2.39	2.86	5.73	8.59	
Maximum torque (N-m)	3.82	7.16	8.59	17.19	21.48	
Rated speed (r/min)	3,000			1,000		
Maximum speed (r/min)	5,000			2,000		
Rated current (A)	2.6	5.1	2.5	4.8	7.5	
Maximum current (A)	7.8	15.3	7.5	14.4	22.5	
Power rating (kW/s)	21.7	19.63	10.0	39.0	66.0	
Rotor moment of inertia (x10 <sup>-4</sup> kg-m <sup>2</sup> )(without brake)	0.743	2.91	8.17	8.41	11.18	
Mechanical time constant (ms)	1.42	1.6	1.84	1.40	1.06	
Torque constant-KT (N-m/A)	0.49	0.47	1.15	1.19	1.15	
Voltage constant-KE (mV/(r/min))	17.4	17.2	42.5	43.8	41.6	
Armature resistance (Ohm)	1.55	0.42	1.06	0.82	0.43	
Armature inductance (mH)	6.71	3.53	14.29	11.12	6.97	
Electrical time constant (ms)	4.3	8.36	13.5	13.50	16.06	
Insulation class	Class A (UL), Class B (CE)					
Insulation resistance	100M $\Omega$ , DC 500V above					
Insulation strength	1.8k Vac,1 sec					
Weight (kg)(without brake)	1.8	3.4	6.8	7.0	7.5	
Weight (kg)(with brake)	2.2	3.9	8.2	8.4	8.9	
Max. radial shaft load (N)	196	245	490	490	490	
Max. thrust shaft load (N)	68	98	98	98	98	
Power rating (kW/s)(with brake)	21.48	19.3	9.2	35.9	62.1	
Rotor moment of inertia (x10 <sup>-4</sup> kg-m <sup>2</sup> )(with brake)	0.751	2.96	8.94	9.14	11.9	
Mechanical time constant (ms)(with brake)	1.43	1.62	2.0	1.51	1.13	
Brake holding torque [Nt-m (min)] <sup>*2</sup>	1.3	2.5	10.0	10.0	10.0	
Brake power consumption (at 20°C)[W]	6.5	8.2	19.0	19.0	19.0	
Brake release time [ms (Max)]	10	10	10	10	10	
Brake pull-in time [ms (Max)]	70	70	70	70	70	
Vibration grade ( $\mu$ m)	15					
Operating temperature (°C)	0°C to 40°C					
Storage temperature (°C)	-10°C to 80°C					
Operating humidity	20 to 90%RH (non-condensing)					
Storage humidity	20 to 90%RH (non-condensing)					
Vibration capacity	2.5G					
IP Rating	IP65 (when waterproof connectors are used, or when an oil seal is used to be fitted to the rotating shaft (an oil seal model is used))					
Approvals						

\*1. Rate torque values are continuous permissible values at 0 ~ 40°C ambient temperature when attaching with the sizes of heatsinks listed below:

ECMA-... 04 / 06 / 08: 250 mm x 250 mm x 6 mm  
 ECMA-... 10: 300 mm x 300 mm x 12 mm  
 ECMA-... 13: 400 mm x 400 mm x 20 mm  
 ECMA-... 18: 550 mm x 550 mm x 30 mm  
 ECMA-... 22: 650 mm x 650 mm x 35 mm

Material type : Aluminum - F40, F60, F80, F100, F130, F180, F220

\*2. The holding brake is used to hold the motor shaft, not for braking the rotation. Never use it for decelerating or stopping the machine.

# Servo Motor Specifications

## Low / Medium Series- 400V Series

ECMA Series	J $\Delta$ 06		J $\Delta$ 08		J $\Delta$ 09		J $\Delta$ 10		J $\Delta$ 13	K $\Delta$ 13				K $\Delta$ 18
	04	07	07	10	10	20	30	05	10	15	20	20		
Rated output power (kW)	0.4	0.75	0.75	1	1.0	2.0	3.0	0.5	1.0	1.5	2.0	2.0		
Rated torque (N-m) <sup>1</sup>	1.27	2.39	2.39	3.18	3.18	6.37	9.55	2.39	4.77	7.16	9.55	9.55		
Maximum torque (N-m)	3.82	7.16	7.14	8.78	9.54	19.1	28.65	7.16	14.32	21.48	28.65	28.65		
Rated speed (r/min)	3,000		3,000		3,000		3,000	2,000						
Maximum speed (r/min)	5,000		3,000		5,000		4,500	3,000						
Rated current (A)	1.62	3.07	2.16	2.4	4.15	7.09	9.8	1.7	3.52	5.02	6.66	6.6		
Maximum current (A)	4.85	9.5	6.37	7.17	12.46	21.28	29.99	5.2	10.56	15.06	19.98	19.88		
Power rating (kW/s)	58.2	50.4	29.6	38.6	38.2	91.2	71.8	6.99	27.1	45.9	62.5	26.3		
Rotor moment of inertia (x10 <sup>-4</sup> kg-m <sup>2</sup> )(without brake)	0.277	1.13	1.93	2.62	2.65	4.45	12.7	8.17	8.41	11.18	14.59	34.68		
Mechanical time constant (ms)	0.47	0.66	1.56	1.06	0.77	0.58	0.99	2.08	1.80	1.24	1.04	1.74		
Torque constant-KT (N-m/A)	0.79	0.78	1.12	1.29	0.77	0.9	0.97	1.41	1.35	1.43	1.43	1.45		
Voltage constant-KE (mV/(r/min))	30.6	28.24	42	50.9	29.0	34.4	37.3	51.5	53.2	55	55	54.0		
Armature resistance (Ohm)	3.95	1.22	3.62	2.58	0.617	0.388	0.269	1.76	1.47	0.83	0.57	0.376		
Armature inductance (mH)	21.3	10.68	21.2	15.28	6.03	4.62	3.55	22.4	17.79	11.67	8.29	7.87		
Electrical time constant (ms)	5.39	8.75	5.85	5.93	9.77	11.9	13.2	12.73	12.04	14.04	14.39	20.9		
Insulation class	Class A (UL), Class B (CE)													
Insulation resistance	100M $\Omega$ , DC 500 V above													
Insulation strength	2.3k Vac, 1 sec													
Weight (kg)(without brake)	1.6	3.0	2.9	3.8	4.3	6.2	7.8	6.8	7.0	7.5	7.8	13.5		
Weight (kg)(with brake)	2	3.8	-	-	4.7	7.2	9.2	8.2	8.4	8.9	9.2	17.5		
Max. radial shaft load (N)	19.6	245	245	245	490	490	490	490	490	490	490	1176		
Max. thrust shaft load (N)	68	98	98	98	98	98	98	98	98	98	98	490		
Power rating (kW/s)(with brake)	53.8	48.4	29.3	37.9	30.4	82	65.1	6.39	24.9	43.1	59.7	24.1		
Rotor moment of inertia (x10 <sup>-4</sup> kg-m <sup>2</sup> )(with brake)	0.3	1.18	1.95	2.67	3.33	4.95	14.0	8.94	9.14	11.90	15.88	37.86		
Mechanical time constant (ms)(with brake)	0.52	0.65	1.57	1.08	0.96	0.65	1.09	2.28	1.96	1.32	1.13	1.9		
Brake holding torque [Nt-m (min)] <sup>2</sup>	1.3	2.5	2.5	2.5	8.0	8.0	10.0	10.0	10.0	10.0	10.0	25.0		
Brake power consumption (at 20°C)[W]	6.5	8.5	8.2	8.2	18.5	18.5	19.0	19.0	19.0	19.0	19.0	20.4		
Brake release time [ms (Max)]	10	10	10	10	10	10	10	10	10	10	10	10		
Brake pull-in time [ms (Max)]	70	70	70	70	70	70	70	70	70	70	70	70		
Vibration grade ( $\mu$ m)	15													
Operating temperature (°C)	0°C to 40°C													
Storage temperature (°C)	-10°C to 80°C													
Operating humidity	20 to 90%RH (non-condensing)													
Storage humidity	20 to 90%RH (non-condensing)													
Vibration capacity	2.5G													
IP Rating	IP65 (when waterproof connectors are used, or when an oil seal is used to be fitted to the rotating shaft (an oil seal model is used))													
Approvals														

\*1. Rate torque values are continuous permissible values at 0 ~ 40°C ambient temperature when attaching with the sizes of heatsinks listed below:

ECMA-...08: 250 mm x 250 mm x 6 mm

ECMA-...13: 400 mm x 400 mm x 20 mm

ECMA-...18: 550 mm x 550 mm x 30 mm

Material type : Aluminum - F80, F130, F180, F220

\*2. The holding brake is used to hold the motor shaft, not for braking the rotation. Never use it for decelerating or stopping the machine.

## Medium-High / High Inertia Series- 400V Series

ECMA Series	L $\Delta$ 13			L $\Delta$ 18				L122		M $\Delta$ 13
	05	08	13	30	45	55	75	1B	1F	09
Rated output power (kW)	0.5	0.85	1.3	3.0	4.5	5.5	7.5	11	15	0.9
Rated torque (N-m) <sup>*1</sup>	3.18	5.39	8.34	19.10	28.65	35.0	47.74	70	95.4	8.59
Maximum torque (N-m)	8.92	13.8	23.3	57.29	71.62	87.53	119.36	175	224	21.48
Rated speed (r/min)	1,500							1,500		1,000
Maximum speed (r/min)	3,000							2,000		2,000
Rated current (A)	2.1	3.4	5.02	11.53	20.8	22.37	27.3	27.2	41.6	4.4
Maximum current (A)	6.1	8.85	15	34.6	52	56	68.3	68	100	13.1
Power rating (kW/s)	7.72	17.0	29.47	66.4	105.5	122.9	159.7	145	201.8	66
Rotor moment of inertia (x10 <sup>-4</sup> kg-m <sup>2</sup> )(without brake)	13.1	17.1	23.6	54.95	77.75	99.78	142.7	338	451	11.18
Mechanical time constant (ms)	2.3	1.76	1.44	1.11	0.94	0.88	0.77	1.42	1.34	1.21
Torque constant-KT (N-m/A)	1.5	1.59	1.66	1.66	1.38	1.56	1.75	2.57	2.29	1.95
Voltage constant-KE (mV/(r/min))	55.5	58.9	61.1	64.4	53	58.9	66.4	96	83.9	71.7
Armature resistance (Ohm)	1.41	0.92	0.59	0.21	0.09	0.07	0.06	0.0994	0.0545	1.45
Armature inductance (mH)	20	14.1	9.54	4.94	2.36	2.2	1.7	2.51	1.43	23.3
Electrical time constant (ms)	14.1	15.33	16.17	23.97	28.07	27.6	28.29	25.25	26.26	16.07
Insulation class	Class A (UL), Class B (CE)									
Insulation resistance	100M $\Omega$ , DC 500V above									
Insulation strength	2.3k Vac,1 sec									
Weight (kg)(without brake)	6.8	8.6	10.7	18.5	23.5	30.5	40.5	56.4	75	7.5
Weight (kg)(with brake)	-	10	--	22.5	29	36	46	68.4	87	8.9
Max. radial shaft load (N)	490	490	490	1,470	1,470	1,764	1,764	3,300	3,300	490
Max. thrust shaft load (N)	98	98	98	490	490	588	588	1,100	1,100	98
Power rating (kW/s)(with brake)	7.02	14.82	27.82	63.9	101.8	119.4	156.6	141.4	197.1	62
Rotor moment of inertia (x10 <sup>-4</sup> kg-m <sup>2</sup> )(with brake)	14.4	19.6	25	57.06	80.65	102.70	145.5	346.5	461.8	11.9
Mechanical time constant (ms)(with brake)	2.54	2.02	1.52	1.16	0.95	0.91	0.79	1.46	1.37	1.29
Brake holding torque [Nt-m (min)] <sup>*2</sup>	10.0	10.0	10.0	25.0	55.0	55.0	55.0	115	115	10.0
Brake power consumption (at 20°C)[W]	19.0	19.0	19.0	20.4	19.9	19.9	19.9	28.8	28.8	19.0
Brake release time [ms (Max)]	10	10	10	10	10	10	10	10	10	10
Brake pull-in time [ms (Max)]	70	70	70	70	70	70	70	70	70	70
Vibration grade ( $\mu$ m)	15									
Operating temperature (°C)	0°C to 40°C									
Storage temperature (°C)	-10°C to 80°C									
Operating humidity	20 to 90%RH (non-condensing)									
Storage humidity	20 to 90%RH (non-condensing)									
Vibration capacity	2.5G									
IP Rating	IP65 (when waterproof connectors are used, or when an oil seal is used to be fitted to the rotating shaft (an oil seal model is used))									
Approvals										

\*1. Rate torque values are continuous permissible values at 0 ~ 40°C ambient temperature when attaching with the sizes of heatsinks listed below:

ECMA-\_\_08: 250 mm x 250 mm x 6 mm

ECMA-\_\_13: 400 mm x 400 mm x 20 mm

ECMA-\_\_18: 550 mm x 550 mm x 30 mm

ECMA-\_\_22: 650 mm x 650 mm x 35 mm

Material type : Aluminum - F80, F130, F180, F220

\*2. The holding brake is used to hold the motor shaft, not for braking the rotation. Never use it for decelerating or stopping the machine.

# Servo Motor Dimensions

## 220V Series

### Frame Size 86 mm and below

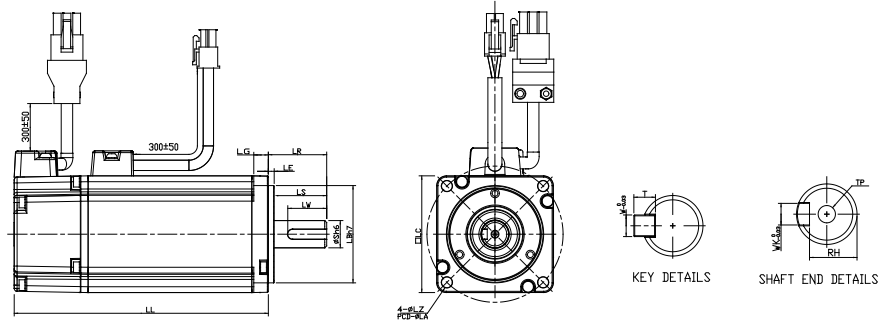

Units: mm

Model	C1040F □ S	C △ 0401 □ S	C △ 0602 □ S	C △ 0604 □ S	C △ 0604 □ H	C △ 0804 □ 7	C △ 0807 □ S	C △ 0807 □ H	C △ 0907 □ S	C △ 0910 □ S
LC	40	40	60	60	60	80	80	80	86	86
LZ	4.5	4.5	5.5	5.5	5.5	6.6	6.6	6.6	6.6	6.6
LA	46	46	70	70	70	90	90	90	100	100
S	8 (+0 -0.009)	8 (+0 -0.009)	14 (+0 -0.011)	14 (+0 -0.011)	14 (+0 -0.011)	14 (+0 -0.011)	19 (+0 -0.013)	19 (+0 -0.013)	16 (+0 -0.011)	16 (+0 -0.011)
LB	30 (+0 -0.021)	30 (+0 -0.021)	50 (+0 -0.025)	50 (+0 -0.025)	50 (+0 -0.025)	70 (+0 -0.030)	70 (+0 -0.030)	70 (+0 -0.030)	80 (+0 -0.030)	80 (+0 -0.030)
LL (without brake)	79.1	100.6	105.5	130.7	145.8	112.3	138.3	154.8	130.2	153.2
LL (with brake)	--	136.8	141.6	166.8	176.37	152.8	178	187.8	161.3	184.3
LS	20	20	27	27	27	27	32	32	30	30
LR	25	25	30	30	30	30	35	35	35	35
LE	2.5	2.5	3	3	3	3	3	3	3	3
LG	5	5	7.5	7.5	7.5	8	8	8	8	8
LW	16	16	20	20	20	20	25	25	20	20
RH	6.2	6.2	11	11	11	11	15.5	15.5	13	13
WK	3	3	5	5	5	5	6	6	5	5
W	3	3	5	5	5	5	6	6	5	5
T	3	3	5	5	5	5	6	6	5	5
TP	M3 Depth 8	M3 Depth 8	M4 Depth 15	M4 Depth 15	M4 Depth 15	M4 Depth 15	M6 Depth 20	M6 Depth 20	M5 Depth 15	M5 Depth 15

- NOTE**
- 1) Dimensions are in millimeters.
  - 2) Dimensions of the servo motors may be revised without prior notice.
  - 3) The boxes (□) in the model names are for optional configurations(keyway, brake and oil seal).
  - 4) The boxes (△) in the model names are for encoder resolution types. (△ =1: Incremental encoder, 20-bit; △ =2: Incremental encoder, 17-bit; △ =A: Absolute type)

## Speed-Torque Curves (T-N Curves)

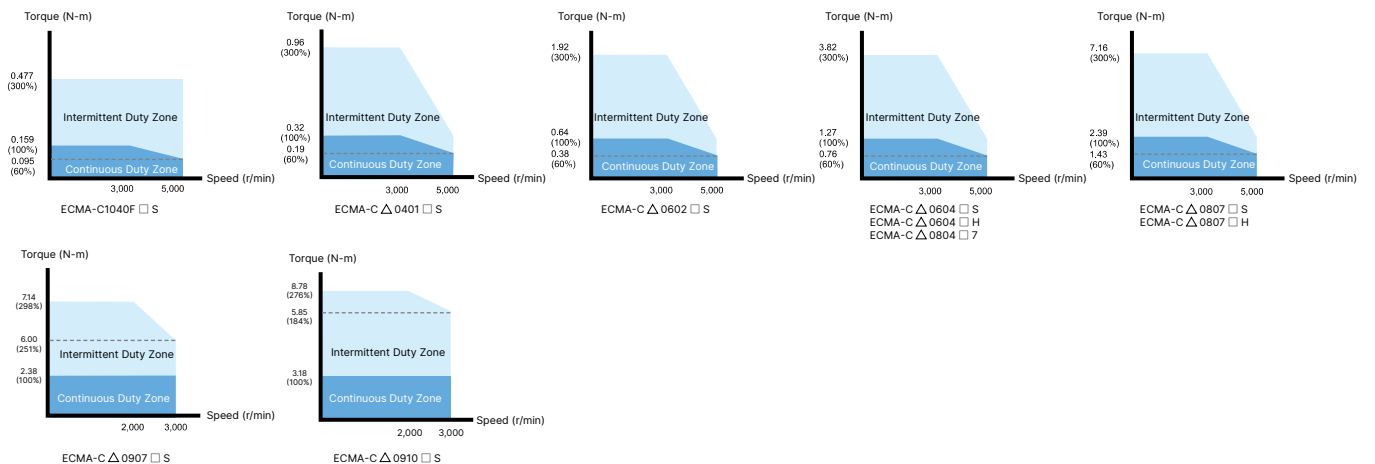

## 220 V Series

### Frame Size 100 mm and 130 mm

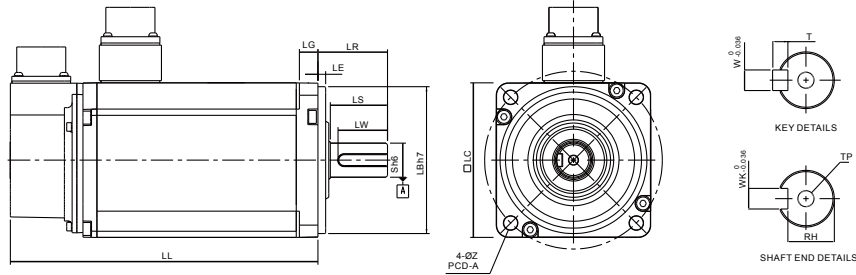

Units: mm

Model	C $\triangle$ 1010 $\square$ S	C $\triangle$ 1020 $\square$ S	C $\triangle$ 1330 $\square$ 4	E $\triangle$ 1305 $\square$ S	E $\triangle$ 1310 $\square$ S	E $\triangle$ 1315 $\square$ S	E $\triangle$ 1320 $\square$ S
LC	100	100	130	130	130	130	130
LZ	9	9	9	9	9	9	9
LA	115	115	145	145	145	145	145
S	22 ( $^{+0}_{-0.013}$ )	22 ( $^{+0}_{-0.013}$ )	24 ( $^{+0}_{-0.013}$ )	22 ( $^{+0}_{-0.013}$ )	22 ( $^{+0}_{-0.013}$ )	22 ( $^{+0}_{-0.013}$ )	22 ( $^{+0}_{-0.013}$ )
LB	95 ( $^{+0}_{-0.035}$ )	95 ( $^{+0}_{-0.035}$ )	110 ( $^{+0}_{-0.035}$ )	110 ( $^{+0}_{-0.035}$ )	110 ( $^{+0}_{-0.035}$ )	110 ( $^{+0}_{-0.035}$ )	110 ( $^{+0}_{-0.035}$ )
LL (without brake)	153.3	199	187.5	147.5	147.5	167.5	187.5
LL (with brake)	192.5	226	216	183.5	183.5	202	216
LS	37	37	47	47	47	47	47
LR	45	45	55	55	55	55	55
LE	5	5	6	6	6	6	6
LG	12	12	11.5	11.5	11.5	11.5	11.5
LW	32	32	36	36	36	36	36
RH	18	18	20	18	18	18	18
WK	8	8	8	8	8	8	8
W	8	8	8	8	8	8	8
T	7	7	7	7	7	7	7
TP	M6 Depth 20	M6 Depth 20	M6 Depth 20	M6 Depth 20	M6 Depth 20	M6 Depth 20	M6 Depth 20

- NOTE**
- 1) Dimensions are in millimeters.
  - 2) Dimensions of the servo motors may be revised without prior notice.
  - 3) The boxes ( $\square$ ) in the model names are for optional configurations (keyway, brake and oil seal).
  - 4) The boxes ( $\triangle$ ) in the model names are for encoder resolution types. ( $\triangle$  = 1: Incremental encoder, 20-bit;  $\triangle$  = 2: Incremental encoder, 17-bit;  $\triangle$  = A: Absolute type)

## Speed-Torque Curves (T-N Curves)

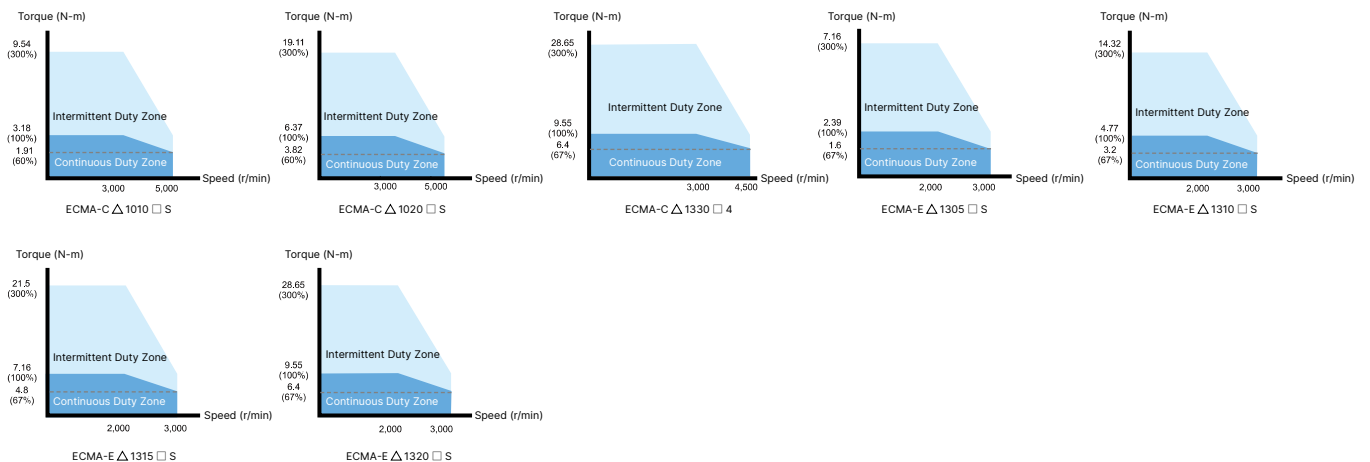

# Servo Motor Dimensions

## 220V Series

### Frame Size 100 mm and 130 mm

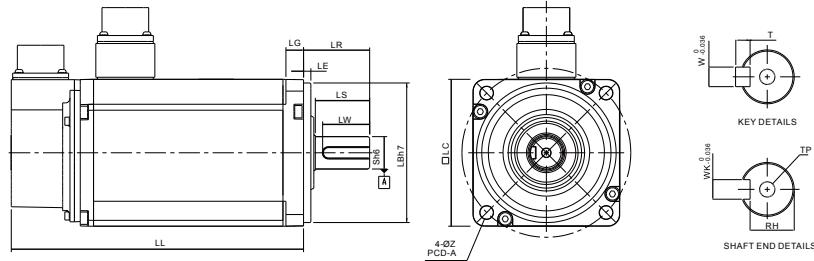

Units: mm

Model	F $\Delta$ 1305 $\square$ S	F $\Delta$ 1308 $\square$ S	F $\Delta$ 1313 $\square$ S	F $\Delta$ 1318 $\square$ S	G $\Delta$ 1303 $\square$ S	G $\Delta$ 1306 $\square$ S	G $\Delta$ 1309 $\square$ S
LC	130	130	130	130	130	130	130
LZ	9	9	9	9	9	9	9
LA	145	145	145	145	145	145	145
S	22 ( $^{+0}_{-0.013}$ )	22 ( $^{+0}_{-0.013}$ )	22 ( $^{+0}_{-0.013}$ )	22 ( $^{+0}_{-0.013}$ )	22 ( $^{+0}_{-0.013}$ )	22 ( $^{+0}_{-0.013}$ )	22 ( $^{+0}_{-0.013}$ )
LB	110 ( $^{+0}_{-0.035}$ )	110 ( $^{+0}_{-0.035}$ )	110 ( $^{+0}_{-0.035}$ )	110 ( $^{+0}_{-0.035}$ )	110 ( $^{+0}_{-0.035}$ )	110 ( $^{+0}_{-0.035}$ )	110 ( $^{+0}_{-0.035}$ )
LL (without brake)	139.5	152.5	187.5	202	147.5	147.5	163.5
LL (with brake)	168	181	216	230.7	183.5	183.5	198
LS	47	47	47	47	47	47	47
LR	55	55	55	55	55	55	55
LE	6	6	6	6	6	6	6
LG	11.5	11.5	11.5	11.5	11.5	11.5	11.5
LW	36	36	36	36	36	36	36
RH	18	18	18	18	18	18	18
WK	8	8	8	8	8	8	8
W	8	8	8	8	8	8	8
T	7	7	7	7	7	7	7
TP	M6 Depth 20	M6 Depth 20	M6 Depth 20	M6 Depth 20	M6 Depth 20	M6 Depth 20	M6 Depth 20

- NOTE**
- 1) Dimensions are in millimeters.
  - 2) Dimensions of the servo motors may be revised without prior notice.
  - 3) The boxes ( $\square$ ) in the model names are for optional configurations (keyway, brake and oil seal).
  - 4) The boxes ( $\Delta$ ) in the model names are for encoder resolution types. ( $\Delta=1$ : Incremental encoder, 20-bit;  $\Delta=2$ : Incremental encoder, 17-bit;  $\Delta=A$ : Absolute type)

## Speed-Torque Curves (T-N Curves)

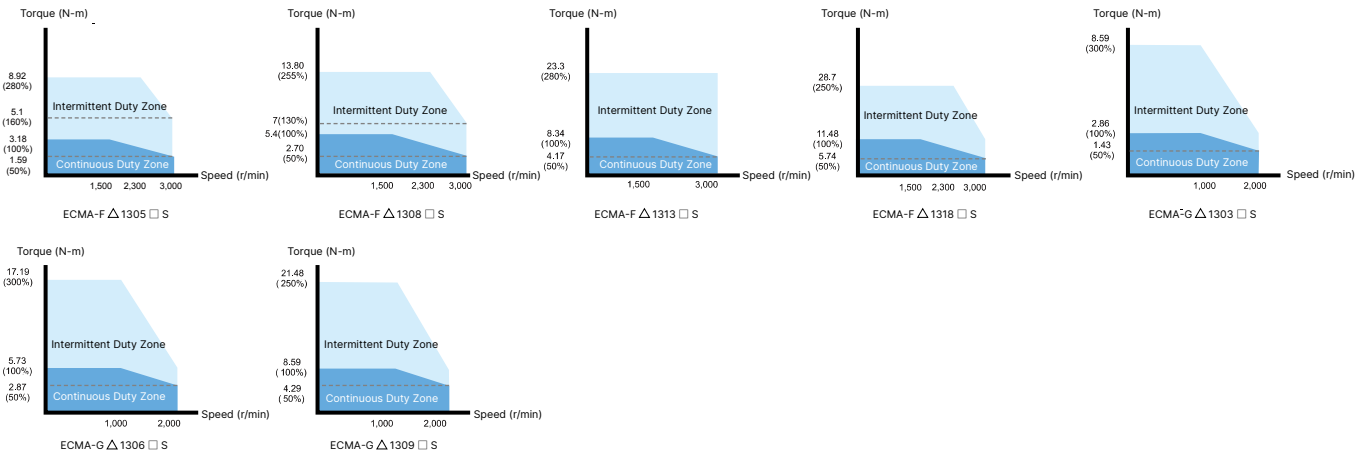



## 220V Series

### Frame Size 180 mm

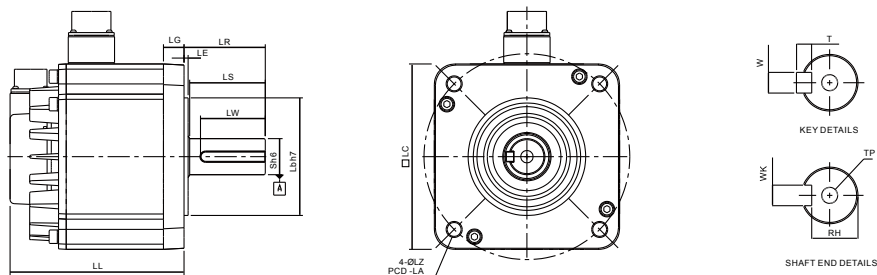

Units: mm

Model	E △ 1820 □ S	E △ 1830 □ S	E △ 1835 □ S	F △ 1845 □ S	F △ 1855 □ 3	F △ 1875 □ 3
LC	180	180	180	180	180	180
LZ	13.5	13.5	13.5	13.5	13.5	13.5
LA	200	200	200	200	200	200
S	35 (+0 / -0.016)	35 (+0 / -0.016)	35 (+0 / -0.016)	35 (+0 / -0.016)	42 (+0 / -0.016)	42 (+0 / -0.016)
LB	114.3 (+0 / -0.035)	114.3 (+0 / -0.035)	114.3 (+0 / -0.035)	114.3 (+0 / -0.035)	114.3 (+0 / -0.035)	114.3 (+0 / -0.035)
LL (without brake)	169	202.1	202.1	235.3	279.7	342.0
LL (with brake)	203.1	235.3	235.3	279.3	311.7	376.1
LS	73	73	73	73	108.5	108.5
LR	79	79	79	79	113	113
LE	4	4	4	4	4	4
LG	20	20	20	20	20	20
LW	63	63	63	63	90	90
RH	30	30	30	30	37	37
WK	10	10	10	10	12	12
W	10	10	10	10	12	12
T	8	8	8	8	8	8
TP	M12 Depth 25	M12 Depth 25	M12 Depth 25	M12 Depth 25	M16 Depth 32	M12 Depth 32



#### NOTE

- 1) Dimensions are in millimeters.
- 2) Dimensions of the servo motors may be revised without prior notice.
- 3) The boxes (□) in the model names are for optional configurations(keyway, brake and oil seal).
- 4) The boxes (△) in the model names are for encoder resolution types. (△=1: Incremental encoder, 20-bit; △=2: Incremental encoder, 17-bit; △=A: Absolute type)

## Speed-Torque Curves (T-N Curves)

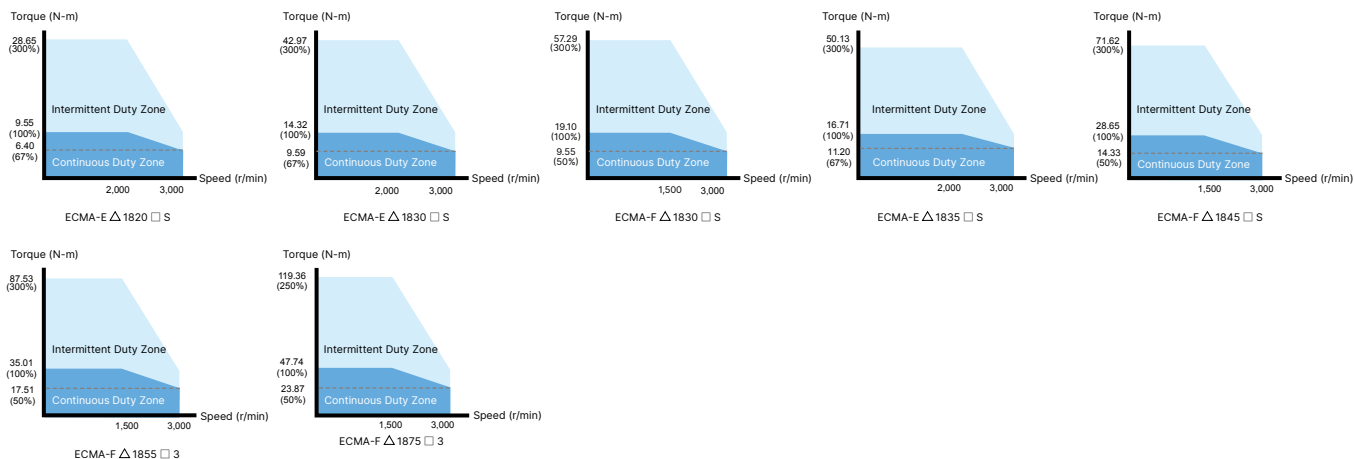

# Servo Motor Dimensions

## 220V / 400V Series

### Frame Size 220 mm and above

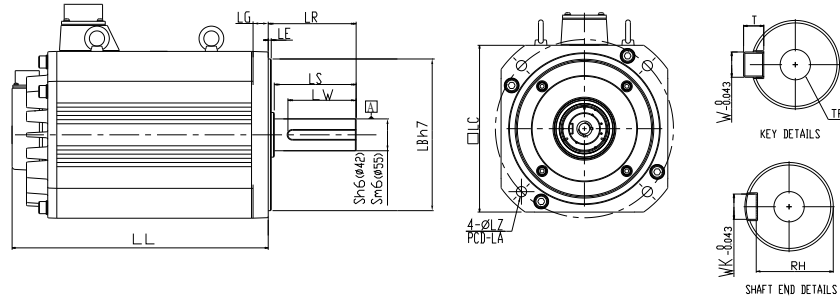

Units: mm

Model	F1221B □ 3	F1221F □ S	L1221B □ 3	L1221F □ S
LC	220	220	220	220
LZ	13.5	13.5	13.5	13.5
LA	235	235	235	235
S	42 ( $^{+0}_{-0.016}$ )	55 ( $^{+0.03}_{-0.011}$ )	42 ( $^{+0}_{-0.016}$ )	55 ( $^{+0.03}_{-0.011}$ )
LB	200 ( $^{+0}_{-0.046}$ )	200 ( $^{+0}_{-0.046}$ )	200 ( $^{+0}_{-0.046}$ )	200 ( $^{+0}_{-0.046}$ )
LL (without brake)	371.4	453.4	371.4	450.4
LL (with brake)	434.4	513.4	434.4	513.4
LS	108	108	110	110
LR	116	116	116	116
LE	4	4	4	4
LG	20	20	20	20
LW	90	90	90	90
RH	37	49	37	49
WK	12	16	12	16
W	12	16	12	16
T	8	10	8	10
TP	M16 Depth 32	M20 Depth 40	M16 Depth 32	M20 Depth 40



- 1) Dimensions are in millimeters.
- 2) Dimensions of the servo motors may be revised without prior notice.
- 3) The boxes ( □ ) in the model names are for optional configurations (keyway, brake and oil seal).

## Speed-Torque Curves (T-N Curves)

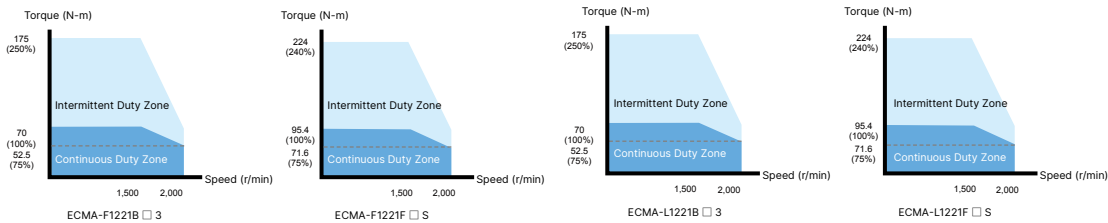

# 400V Series

## Frame Size 80 mm and below

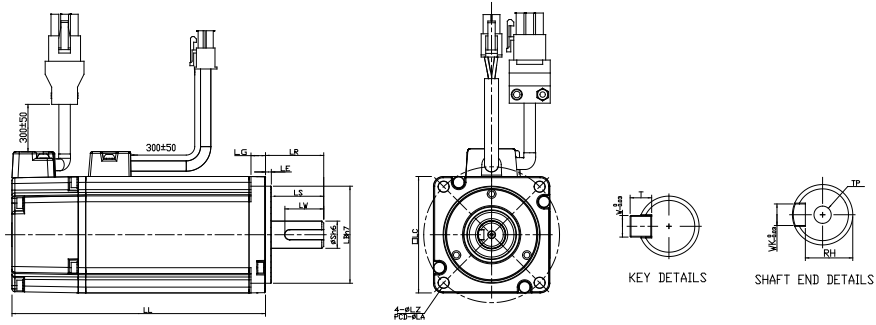

Units: mm

Model	J $\Delta$ 0604 $\square$ S	J $\Delta$ 0807 $\square$ S	J $\Delta$ 0907 $\square$ S	J $\Delta$ 0910 $\square$ S
LC	60	80	86	86
LZ	5.5	6.6	6.6	6.6
LA	70	90	100	100
S	14( $^{+0}_{-0.011}$ )	19( $^{+0}_{-0.013}$ )	16( $^{+0}_{-0.011}$ )	16( $^{+0}_{-0.011}$ )
LB	50( $^{+0}_{-0.025}$ )	70( $^{+0}_{-0.030}$ )	80( $^{+0}_{-0.030}$ )	80( $^{+0}_{-0.030}$ )
LL (without brake)	130.7	138.3	130.2	153.2
LL (with brake)	166.8	178	161.3	184.3
LS (without oil seal)	27	32	30	30
LS (with oil seal)	--	29.5	30	30
LR	30	35	35	35
LE	3	3	3	3
LG	7.5	8	8	8
LW	20	25	20	20
RH	11	15.5	13	13
WK	5	6	5	5
W	5	6	5	5
T	5	6	5	5
TP	M4 Depth 15	M6 Depth 20	M5 Depth 15	M5 Depth 15

- NOTE**
- 1) Dimensions are in millimeters.
  - 2) Dimensions of the servo motors may be revised without prior notice.
  - 3) The boxes ( $\square$ ) in the model names are for optional configurations (keyway, brake and oil seal).
  - 4) The boxes ( $\Delta$ ) in the model names are for encoder resolution types ( $\Delta$  =1: Incremental encoder, 20-bit;  $\Delta$  =2: Incremental encoder, 17-bit;  $\Delta$  =A: Absolute type)

## Speed-Torque Curves (T-N Curves)

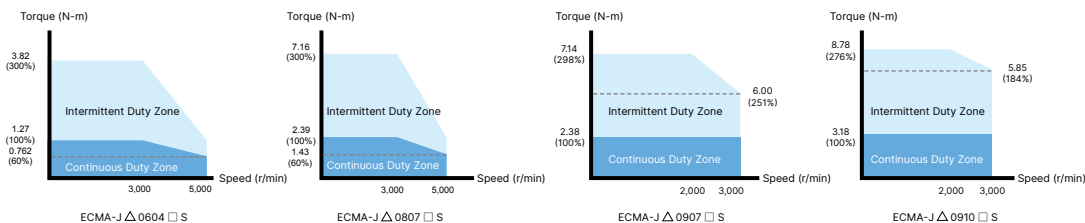

# Servo Motor Dimensions

## 400 V Series

### Frame Size 100 mm and 130 mm

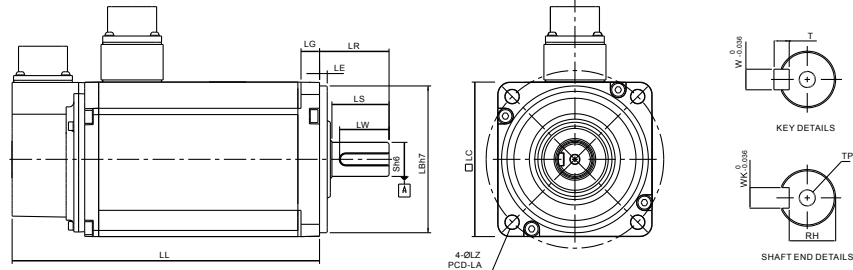

Units: mm

Model	J $\Delta$ 1010 $\square$ S	J $\Delta$ 1020 $\square$ S	J $\Delta$ 1330 $\square$ 4	K $\Delta$ 1305 $\square$ S	K $\Delta$ 1310 $\square$ S	K $\Delta$ 1315 $\square$ S	K $\Delta$ 1320 $\square$ S	L $\Delta$ 1305 $\square$ S	L $\Delta$ 1308 $\square$ S	L $\Delta$ 1313 $\square$ S	
LC	100	100	130	130	130	130	130	130	130	130	
LZ	9	9	9	9	9	9	9	9	9	9	
LA	115	115	145	145	145	145	145	145	145	145	
S	22 ( $^{+0}_{-0.013}$ )	22 ( $^{+0}_{-0.013}$ )	24 ( $^{+0}_{-0.013}$ )	22 ( $^{+0}_{-0.013}$ )	22 ( $^{+0}_{-0.013}$ )	22 ( $^{+0}_{-0.013}$ )	22 ( $^{+0}_{-0.013}$ )	22 ( $^{+0}_{-0.013}$ )	22 ( $^{+0}_{-0.013}$ )	22 ( $^{+0}_{-0.013}$ )	
LB	95 ( $^{+0}_{-0.035}$ )	95 ( $^{+0}_{-0.035}$ )	110 ( $^{+0}_{-0.035}$ )	110 ( $^{+0}_{-0.035}$ )	110 ( $^{+0}_{-0.035}$ )	110 ( $^{+0}_{-0.035}$ )	110 ( $^{+0}_{-0.035}$ )	110 ( $^{+0}_{-0.035}$ )	110 ( $^{+0}_{-0.035}$ )	110 ( $^{+0}_{-0.035}$ )	
LL (without brake)	153.3	199	187.5	139.5	147.5	167.5	187.5	147.5	163.5	194.5	
LL (with brake)	192.5	226	216.0	168	183.5	202	216	183.2	198	223	
LS	37	37	47	47	47	47	47	47	47	47	
LR	45	45	55	55	55	55	55	55	55	55	
LE	5	5	6	6	6	6	6	6	6	6	
LG	12	12	11.5	11.5	11.5	11.5	11.5	11.5	11.5	11.5	
LW	32	32	36	36	36	36	36	36	36	36	
RH	18	18	20	18	18	18	18	18	18	18	
WK	8	8	8	8	8	8	8	8	8	8	
W	8	8	8	8	8	8	8	8	8	8	
T	7	7	7	7	7	7	7	7	7	7	
TP	MP6 Depth 20	MP6 Depth 20	MP6 Depth 20	MP6 Depth 20	MP6 Depth 20	MP6 Depth 20	MP6 Depth 20	MP6 Depth 20	M8 Depth 25	MP6 Depth 20	MP6 Depth 20

- NOTE**
- 1) Dimensions are in millimeters.
  - 2) Dimensions of the servo motors may be revised without prior notice.
  - 3) The boxes ( $\square$ ) in the model names are for optional configurations (keyway, brake and oil seal).
  - 4) The boxes ( $\Delta$ ) in the model names are for encoder resolution types ( $\Delta=1$ : Incremental encoder, 20-bit;  $\Delta=2$ : Incremental encoder, 17-bit);  $\Delta=A$ : Absolute type

## Speed-Torque Curves (T-N Curves)

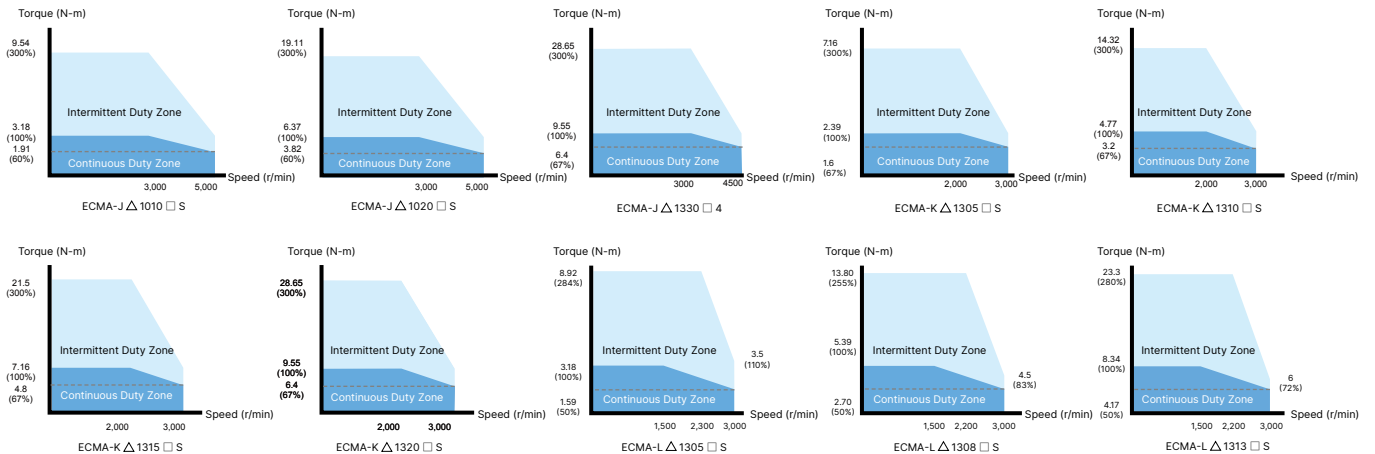

# 400V Series

## Frame Size 180 mm and above

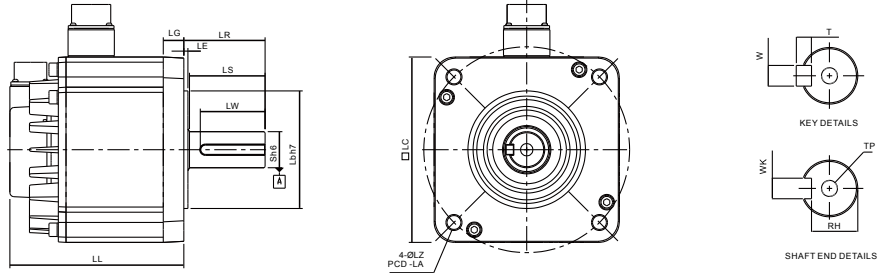

Units: mm

Model	K $\Delta$ 1820 $\square$ S	L $\Delta$ 1830 $\square$ S	L $\Delta$ 1845 $\square$ S	L $\Delta$ 1855 $\square$ 3	L $\Delta$ 1875 $\square$ S	M $\Delta$ 1309 $\square$ S
LC	180	180	180	180	180	130
LZ	13.5	13.5	13.5	13.5	13.5	9
LA	200	200	200	200	200	145
S	35 (+0 / -0.016)	35 (+0 / -0.016)	35 (+0 / -0.016)	42 (+0 / -0.016)	42 (+0 / -0.016)	22 (+0 / -0.013)
LB	114.3 (+0 / -0.035)	114.3 (+0 / -0.035)	114.3 (+0 / -0.035)	114.3 (+0 / -0.035)	114.3 (+0 / -0.035)	110 (+0 / -0.035)
LL (without brake)	169	202.1	235.3	279.7	342.0	163.5
LL (with brake)	203.1	235.3	279.3	311.7	376.1	198
LS	73	73	73	108.5	108.5	47
LR	79	79	79	113	113	55
LE	4	4	4	4	4	6
LG	20	20	20	20	20	11.5
LW	63	63	63	90	90	36
RH	30	30	30	37	37	18
WK	10	10	10	12	12	8
W	10	10	10	12	12	8
T	8	8	8	8	8	7
TP	M12 Depth 25	M12 Depth 25	M12 Depth 25	M16 Depth 32	M16 Depth 32	M6 Depth 20



- NOTE**
- 1) Dimensions are in millimeters.
  - 2) Dimensions of the servo motors may be revised without prior notice.
  - 3) The boxes ( $\square$ ) in the model names are for optional configurations (keyway, brake and oil seal).
  - 4) The boxes ( $\Delta$ ) in the model names are for encoder resolution types ( $\Delta=1$ : Incremental encoder, 20-bit;  $\Delta=2$ : Incremental encoder, 17-bit);  $\Delta=A$ : Absolute type

## Speed-Torque Curves (T-N Curves)

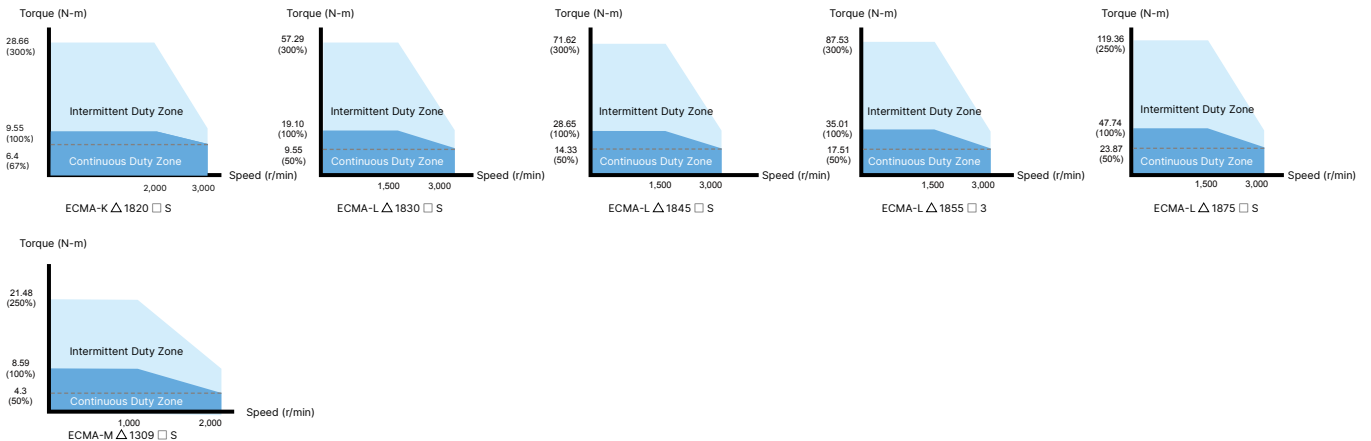

# Part Names and Functions

## ● LED Display / Operation Panel / Charge LED

### • LED Display

The 5 digit, 7 segment LED displays the servo status or fault codes.

### • Operation Panel

Function keys used to perform status display, monitor and diagnostic, function and parameter setting.

Function Keys:

- MODE : Press this key to select/change mode
- SHIFT : Press this key to shift cursor to the left
- UP : Press this key to increase values on the display
- DOWN : Press this key to decrease values on the display
- SET : Press this key to store data

### • Charge LED

A lit LED indicates that either power is connected to the servo drive or a residual charge is present in the drive's internal power components.

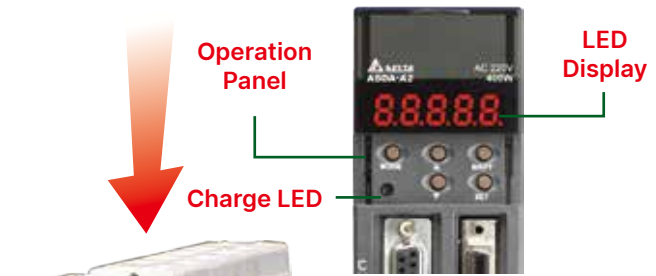

## ● Full-Closed Loop Control Interface

- Used to connect linear scale and encoder for controlling A, B, Z phase signals.

## ● I/O Interface

- Used to connect Delta's DVP series PLC or other external controllers for controlling I/O signals.

## ● High-speed Communication Port

- 1-in/1-out communication ports offer easy serial connection.

## ● Motor Encoder Interface

- Used to connect the encoder of the servo motor

## ● Extension Digital Input Connection Port

- Used to connect a removable digital input terminal block. Max. 6 digital inputs can be added.

## ● Serial Communication Port

- Used to connect PLC, HMI, and other controllers for RS-485 / RS-232 serial communication.

## ● USB Connection Port

- Used to connect personal computers or notebooks.
- Ver 1.1 USB is equipped as standard.
- Direct connectivity to personal computers or notebooks, capable of accessing data through ASDA-Soft configuration software.
- Monitor speed upon software is up to 1Mbps.

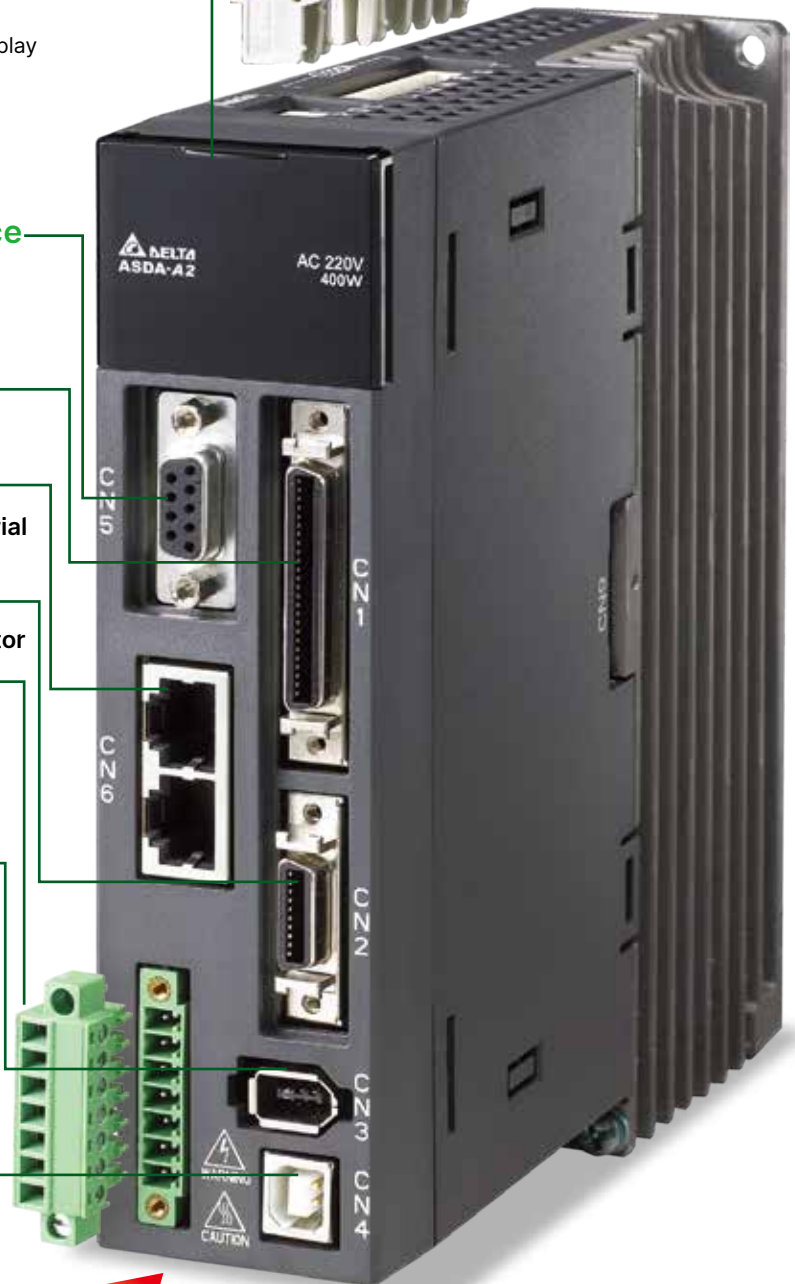

## ● Internal & External Regenerative Resistor Terminal / Control Circuit Terminal / Main Circuit Terminal

### ● Internal & External Regenerative Resistor Terminal

1. When using an external resistor, connect it to P ⊕ and C , and ensure an open circuit between P ⊕ and D.
2. When using an internal resistor, ensure the circuit is closed between P ⊕ and D, and the circuit is open between P ⊕ and C. (Note: Please refer to the table of regenerative resistor specifications for the models with a built-in regenerative resistor.)
3. When using an external braking unit, connect it to P ⊕ and , and ensure an open circuit between P ⊕ and D, and P ⊕ and C.

### ● When using an external braking unit, connect it to P ⊕ and ⊖

### ● Control Circuit Terminal (L1C, L2C or DC24V, DC0V)

- 220 V Series: L1C, L2C are used to connect 200 ~ 230 Vac, 50/60Hz single-phase or three-phase power supply.
- 400 V Series: DC24V, DC0V are used to connect 24Vdc ±10% power supply.

### ● Main Circuit Terminal (R, S, T)

- 220 V Series: Used to connect 200 ~ 230 Vac, 50/60Hz commercial power supply.
- 400 V Series: Used to connect 380 ~ 480 Vac, 50/60Hz commercial power supply.

### ● Servo Motor Output (U, V, W)

- Used to connect servo motor. Never connect the output terminal to main circuit power as the AC drive may be damaged beyond repair if incorrect cables are connected to the output terminals.

### ● Ground Terminal

- Used to connect grounding wire of power supply and servo motor.

### ● Heatsink

- Used to secure servo drive and for heat dissipation.

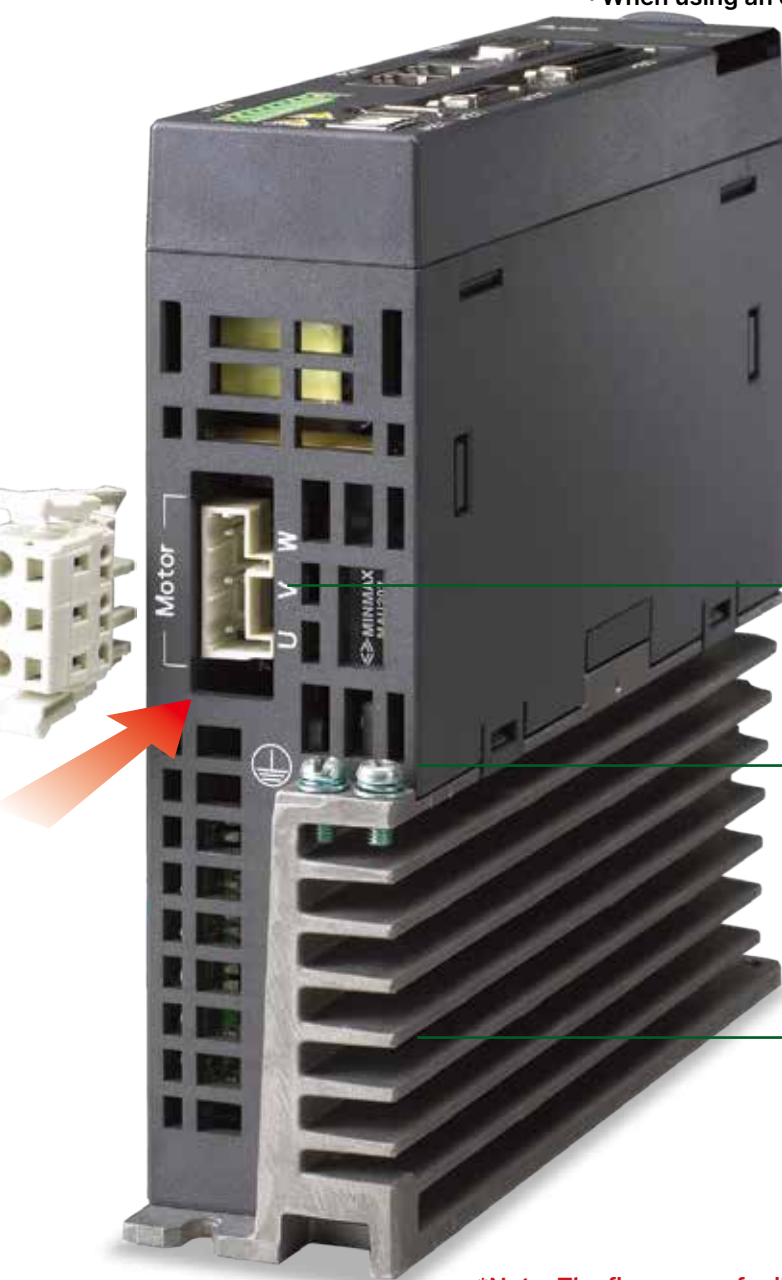

**\*Note: The figures are for illustration purposes only. Actual models may differ slightly in appearance to illustrations provided.**

# Wiring

## 200 V Series

### Position (PT) Control Mode (for Pulse Command Input)

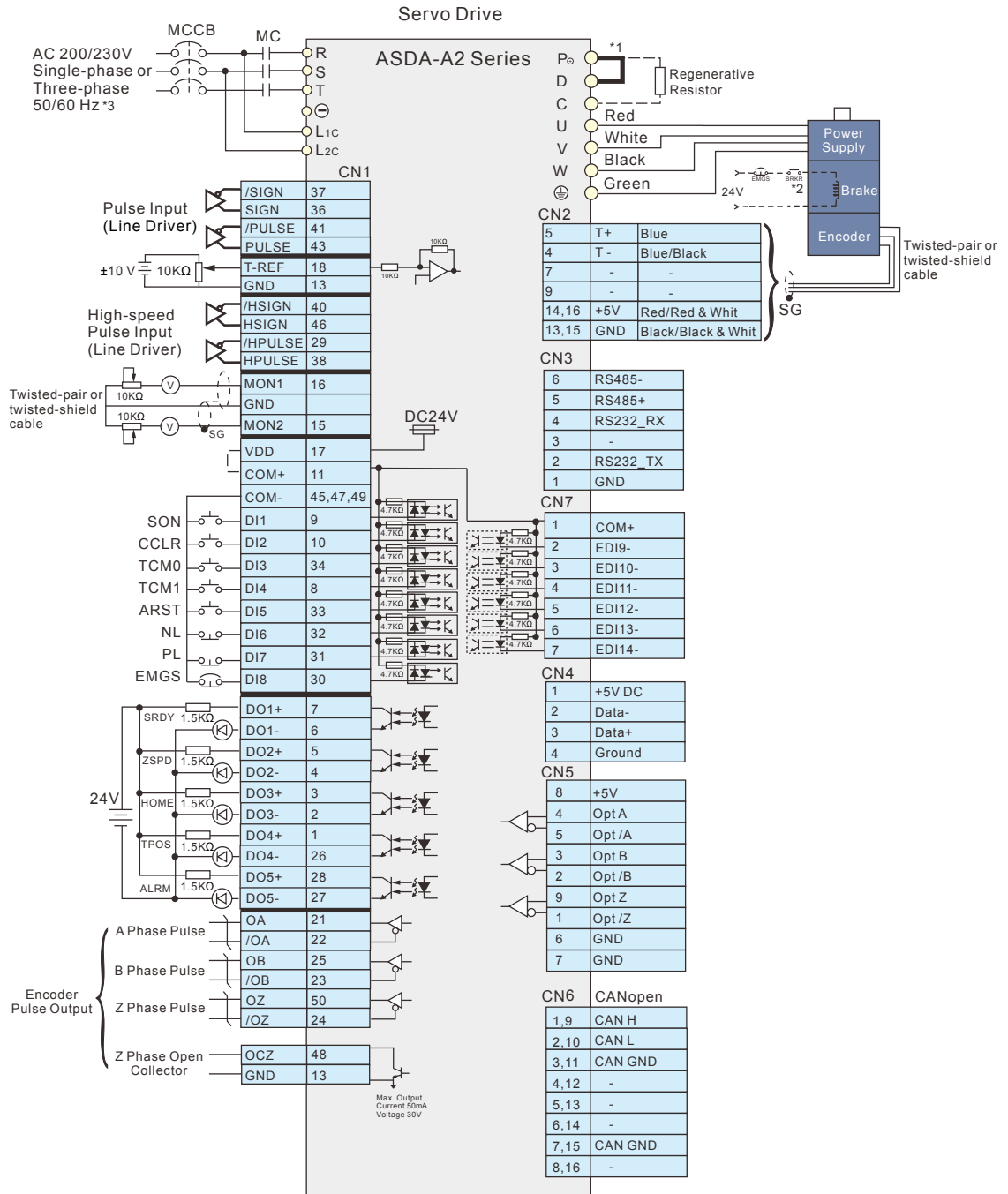
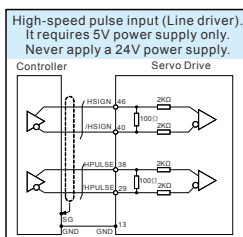
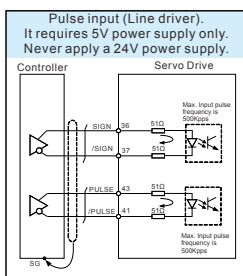
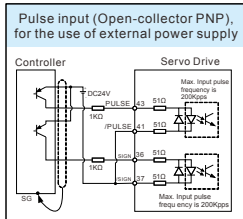
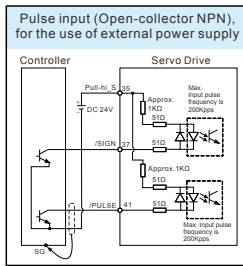
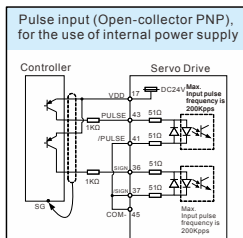
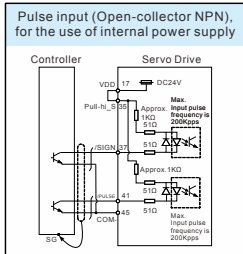

**Please note:**

- \*1. 400W ~ 4.5kW servo drives provide a built-in regenerative resistor.
- \*2. The brake oil has no polarity.
- \*3. Single-phase connections are for servo drives 1.5kW and below only.



# 200V Series

## Position (PR) Control Mode (for Internal Procedure Control)

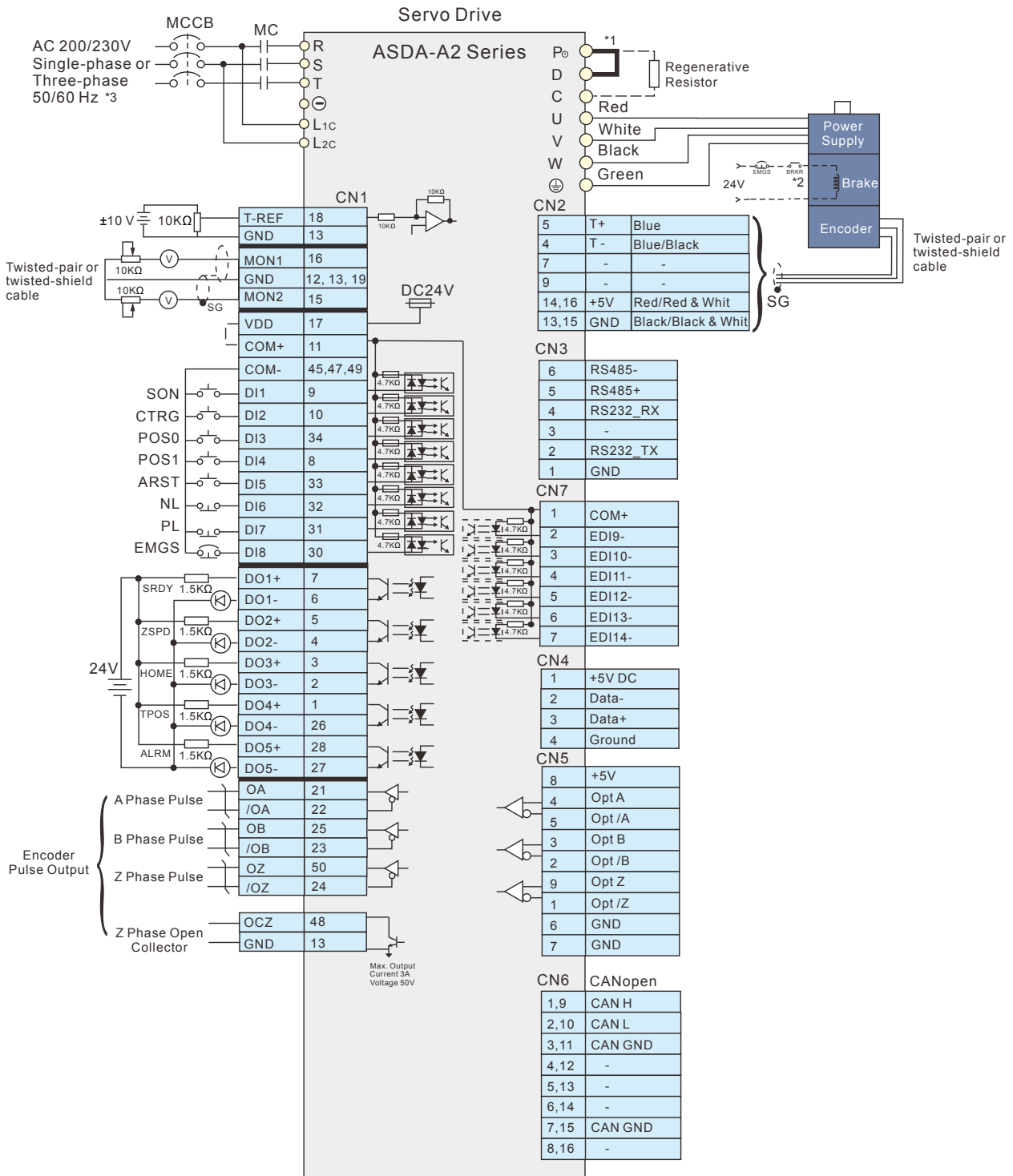

**Please note:**

- \*1. 400W ~ 4.5kW servo drives provide a built-in regenerative resistor.
- \*2. The brake oil has no polarity.
- \*3. Single-phase connections are for servo drives 1.5kW and below only.

# Wiring

## 200V Series

Speed (S), Torque (T) Control Mode (for Analog Voltage Input and Internal Parameter Setting)

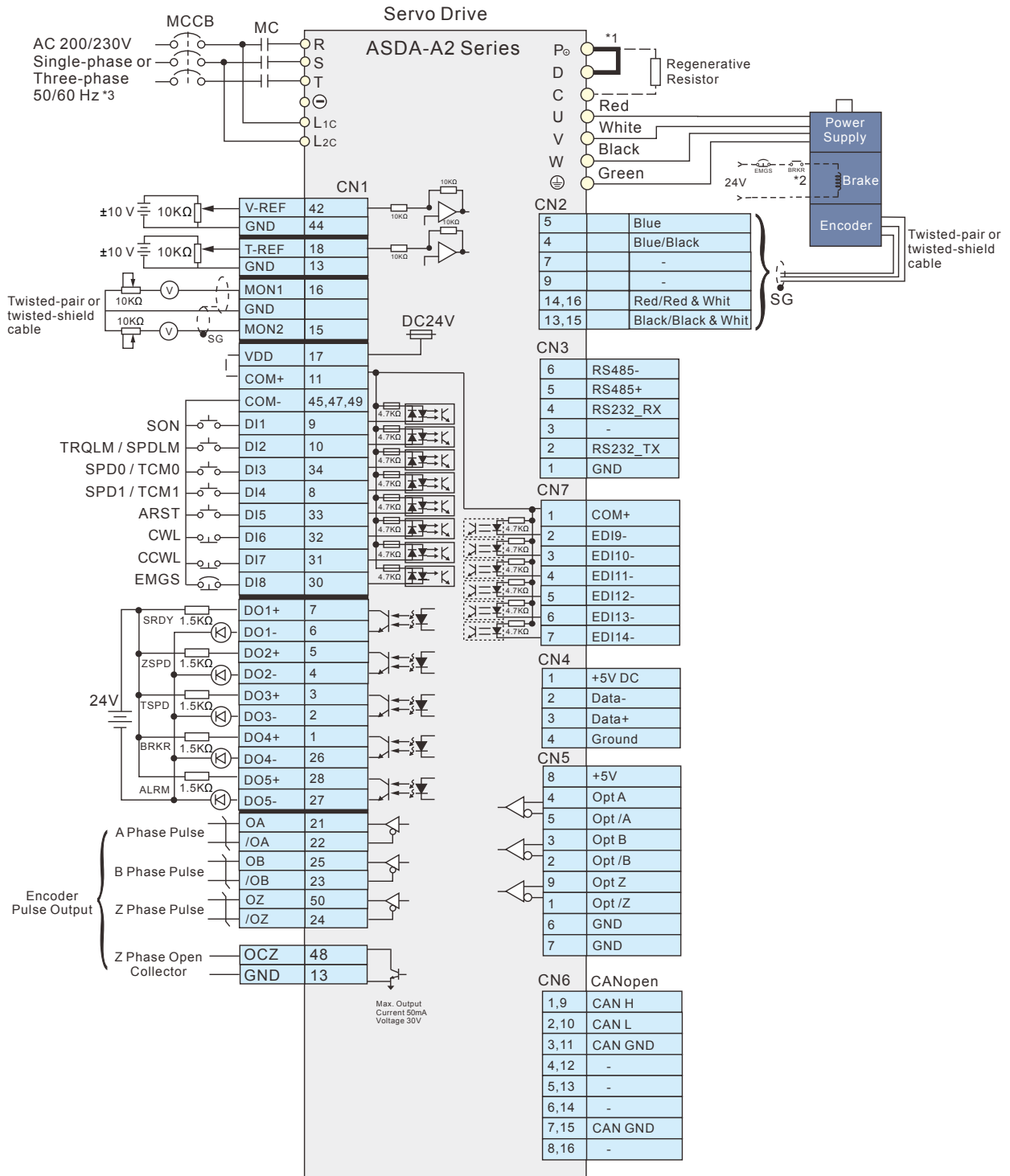

**Please note:**

- \*1. 400W ~ 4.5kW servo drives provide a built-in regenerative resistor.
- \*2. The brake oil has no polarity.
- \*3. Single-phase connections are for servo drives 1.5kW and below only.

# 200V Series

## CANopen Communication Mode

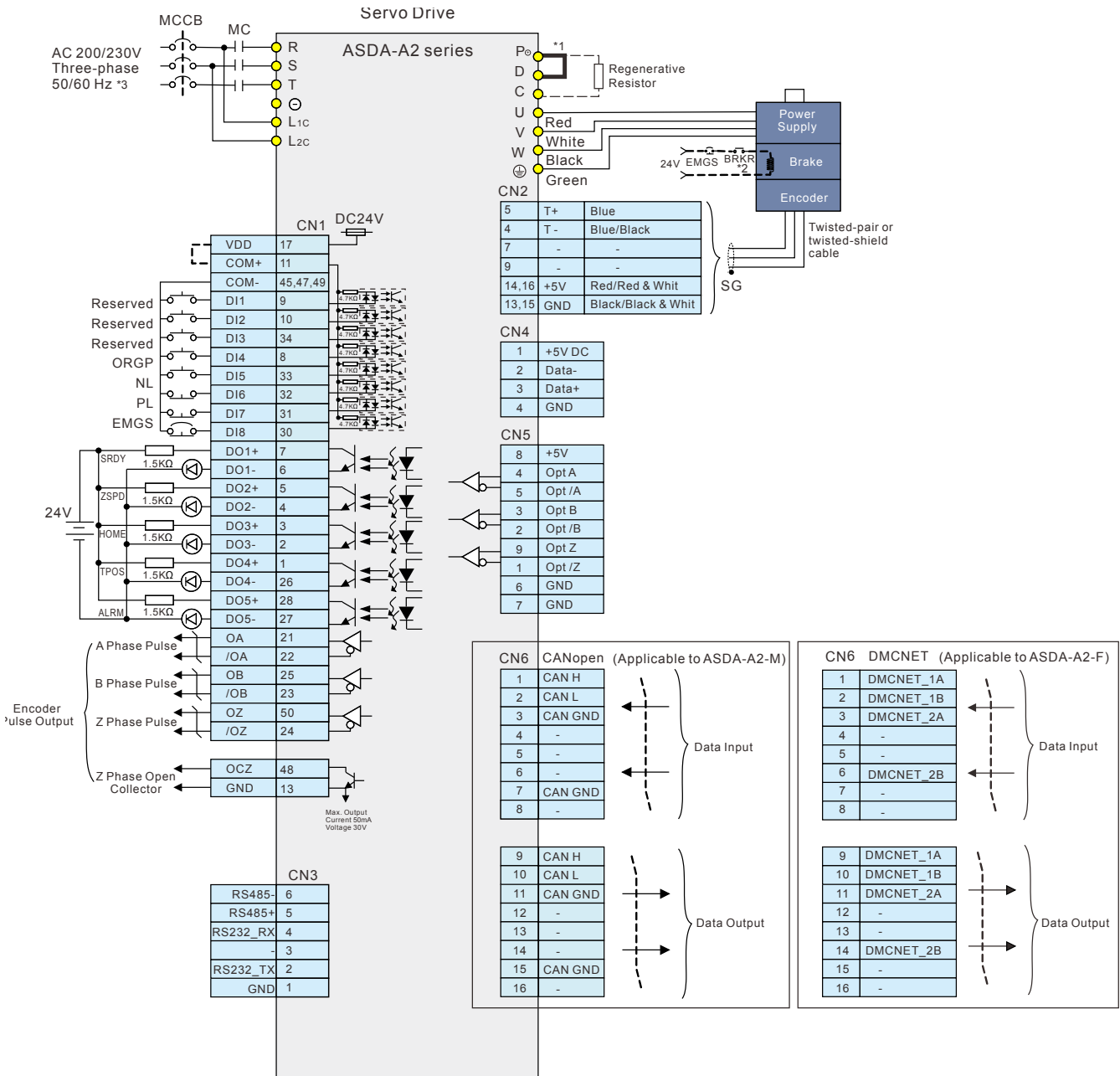

**Please note:**

- \*1. 400W ~ 4.5kW servo drives provide a built-in regenerative resistor.
- \*2. The brake oil has no polarity.
- \*3. Single-phase connections are for servo drives 1.5kW and below only.

# Wiring

## 400 V Series

### Position (PT) Control Mode (for Pulse Command Input)

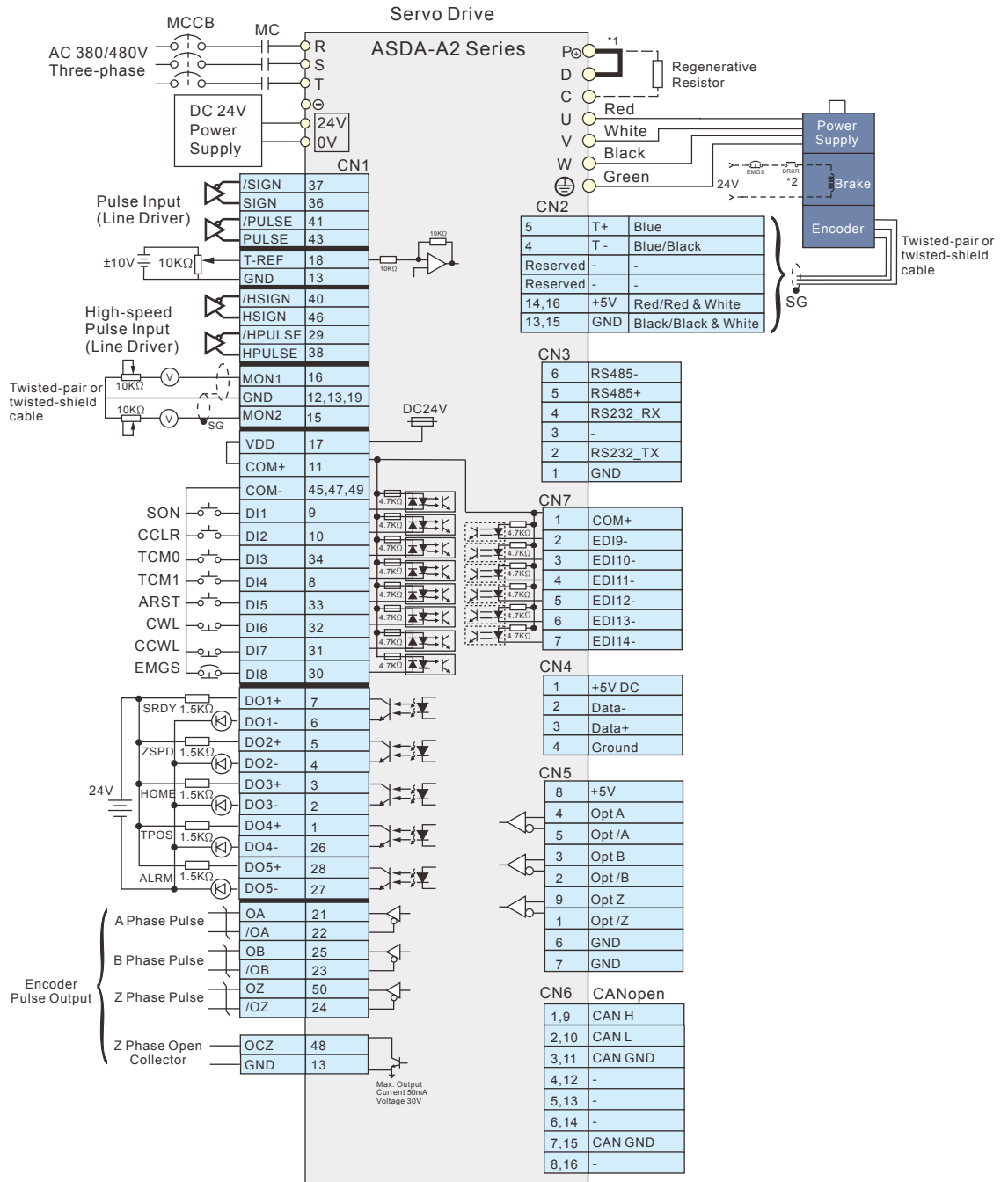
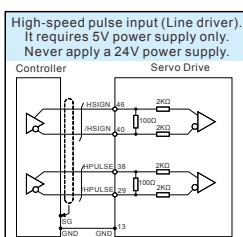
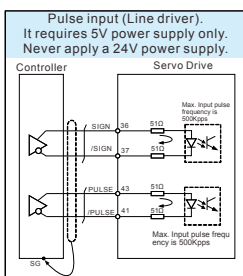
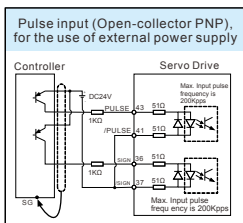
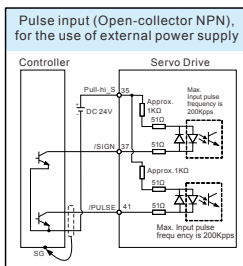
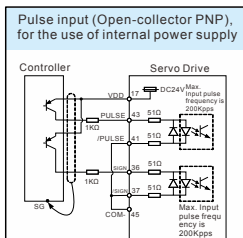
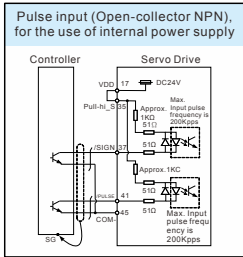

**Please note:**

- \*1 Servo drives under 1.5kW provide a built-in regenerative resistor.
- \*2 The brake oil has no polarity.

# 400V Series

## Position (PR) Control Mode (for Internal Procedure Control)

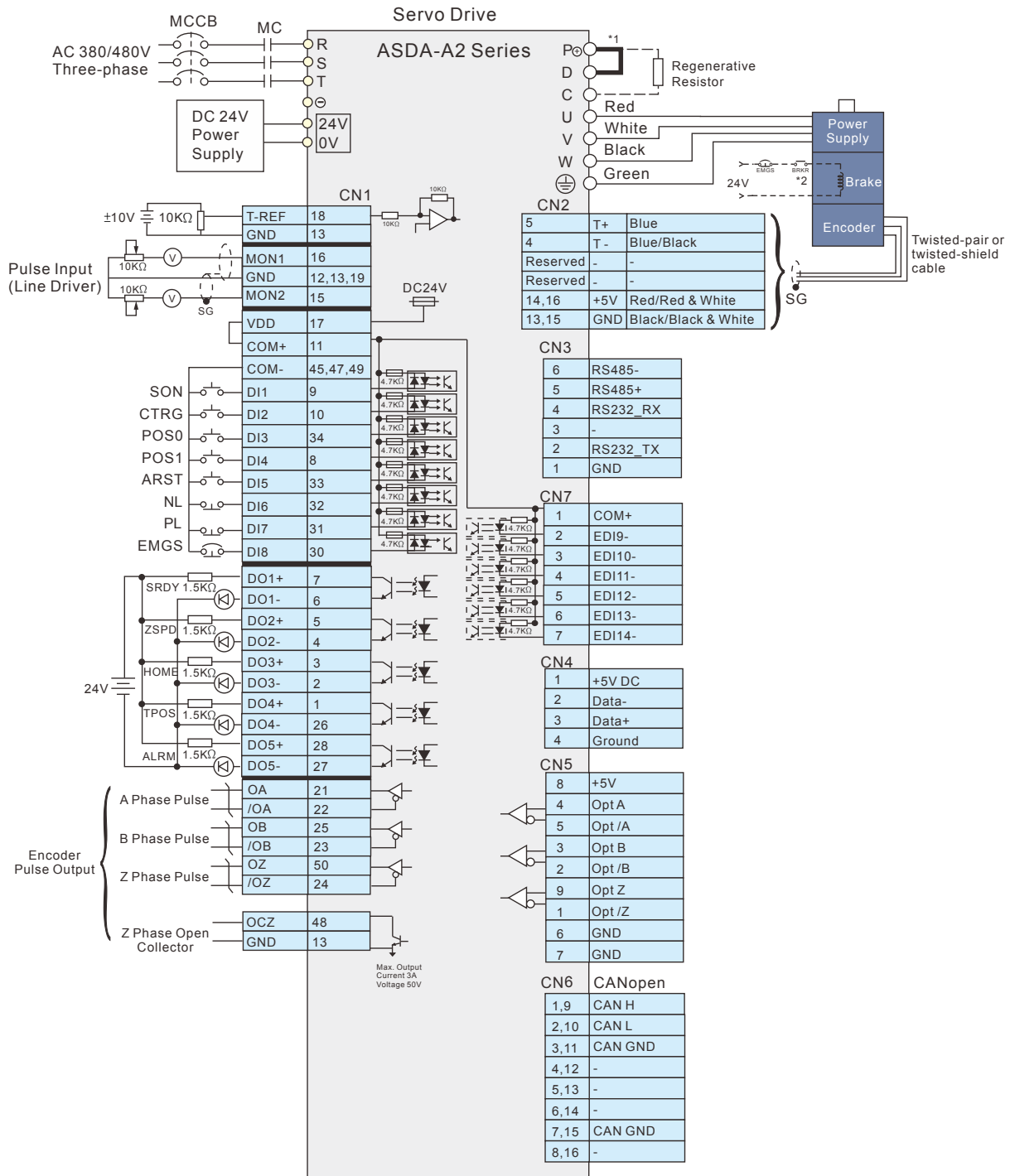

**Please note:**

- \*1 Servo drives under 1.5kW provide a built-in regenerative resistor.
- \*2 The brake oil has no polarity.

# Wiring

## 400 V Series

Speed (S), Torque (T) Control Mode (for Analog Voltage Input and Internal Parameter Setting)

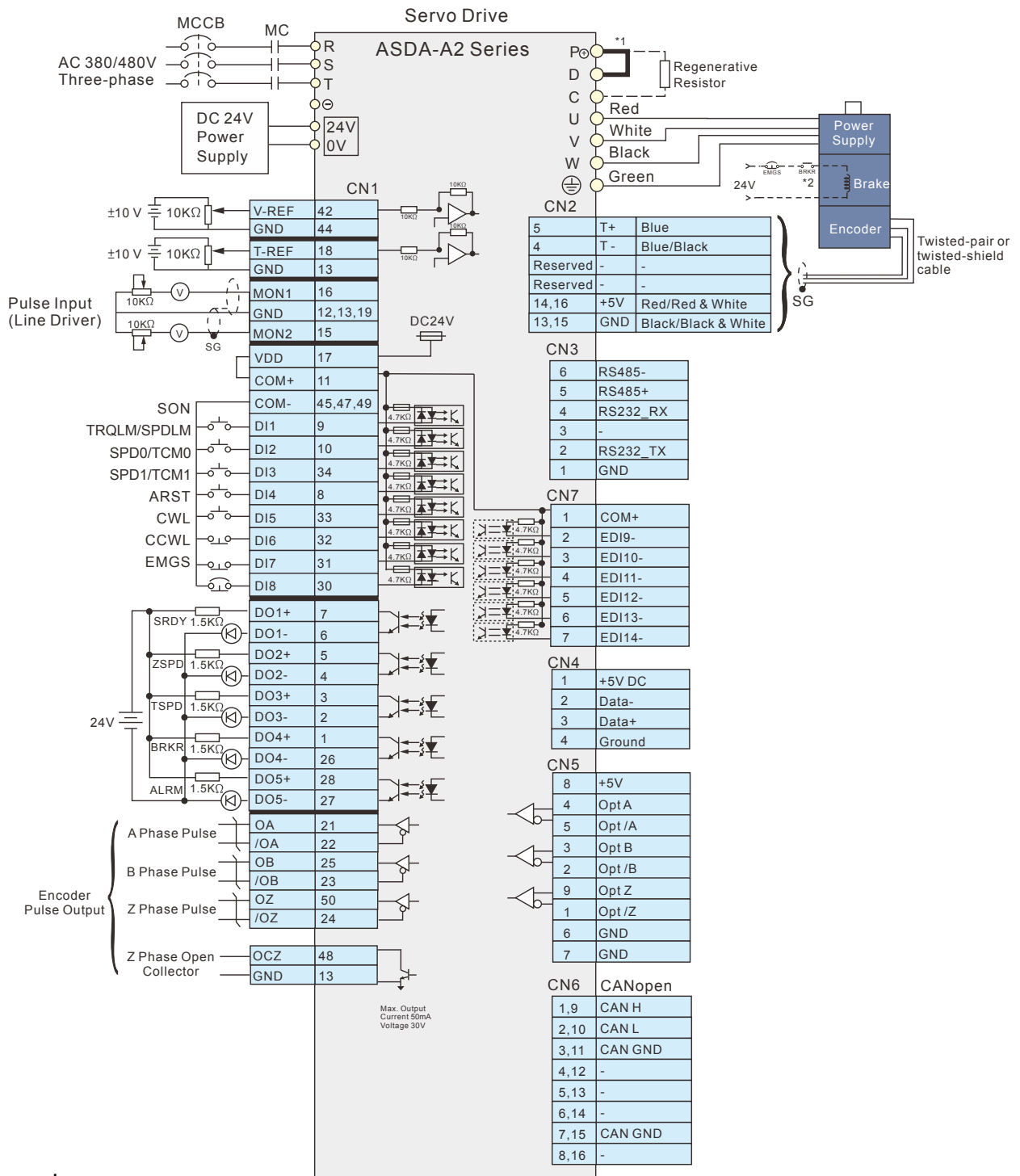

**Please note:**

- \*1 Servo drives under 1.5kW provide a built-in regenerative resistor.
- \*2 The brake oil has no polarity.

# 400V Series

## CANopen Communication Mode (for ASDA-A2-M Series)

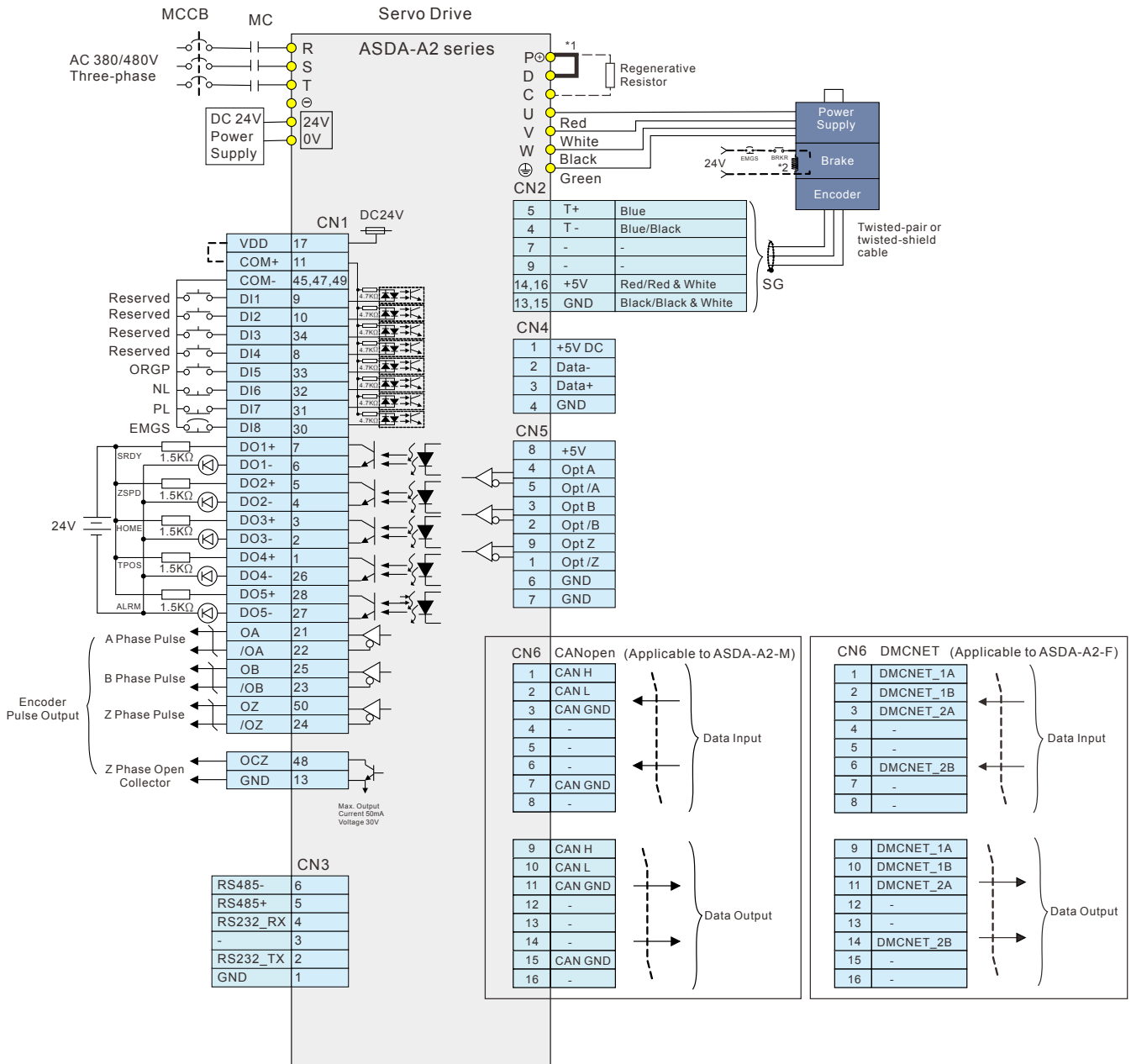

**Please note:**

- \*1 Servo drives under 1.5kW provide a built-in regenerative resistor.
- \*2 The brake oil has no polarity.

# ASDA-Soft Configuration Software

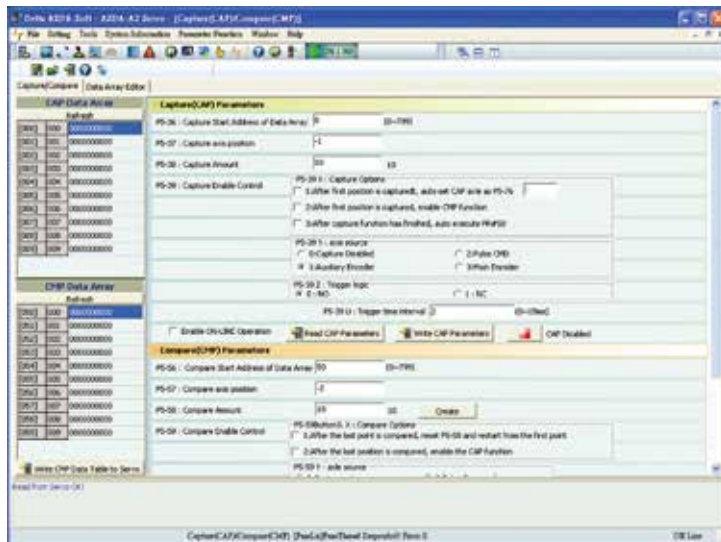

- Strong CAPTURE and COMPARE functions for position latch and detection help you complete system configuration quickly.

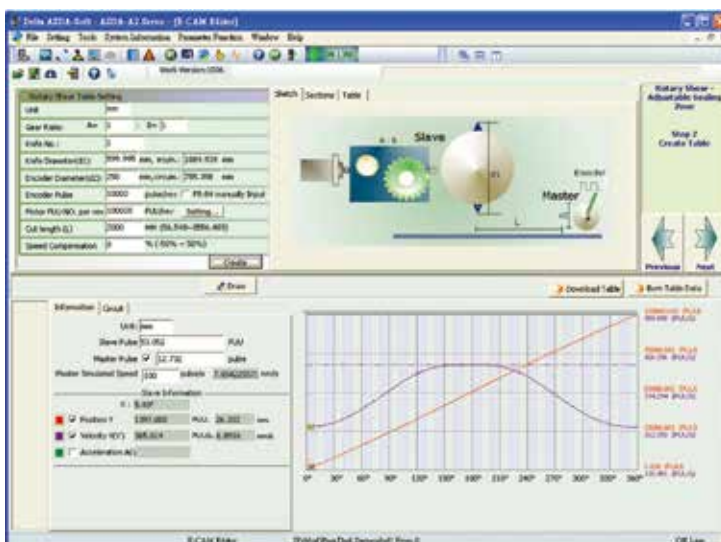

- User-friendly E-CAM editing interface is provided for designing E-CAM outlines and curves freely. In addition, quick settings for flying shear and rotary cut applications are offered.



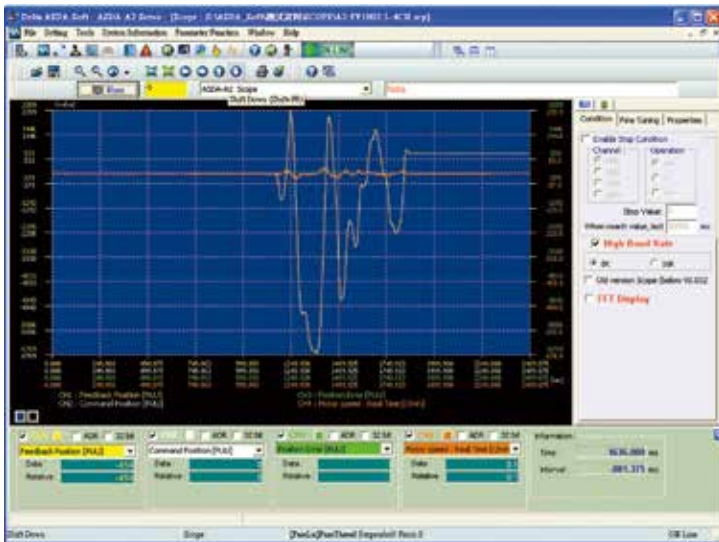

- Versatile on-line monitoring function, similar to a digital oscilloscope is able to quickly record the status and data of each axis. Real-time monitoring is easy.

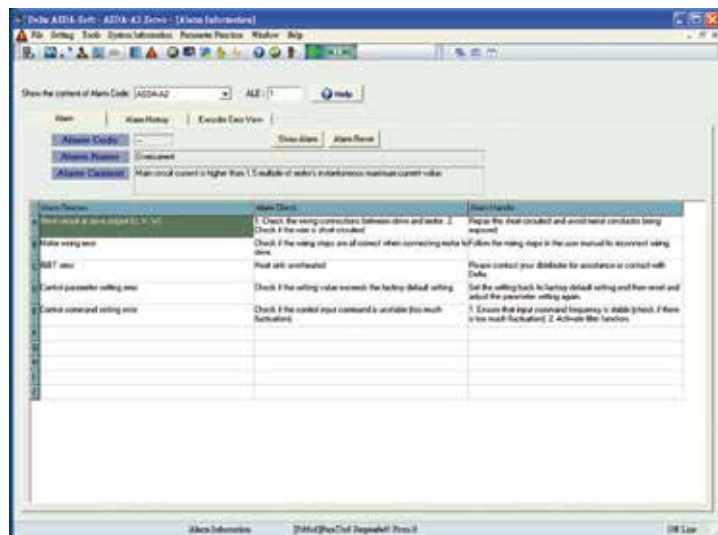

- Convenient alarm display function is capable of troubleshooting the system easily and recommending timely corrective actions.

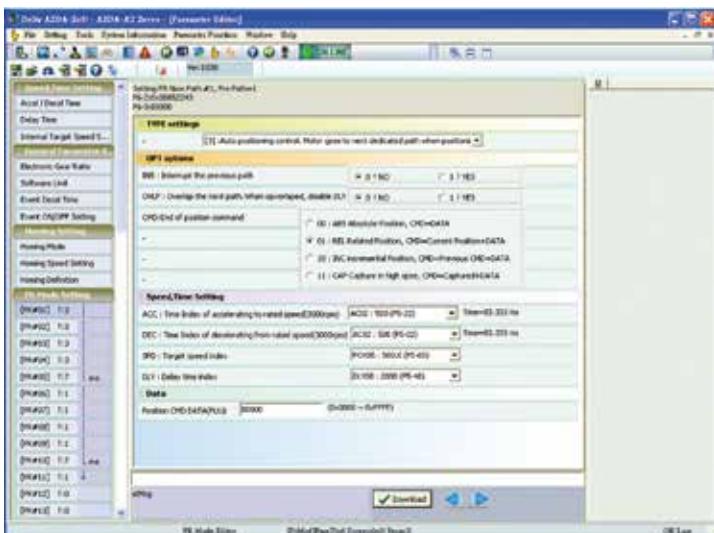

- Easy-to-use editing interface is designed for new and enhanced PR control mode. Homing, point-to-point and other motion control functions for multi-axis positioning control are easily achieved.

## Optional Accessories

### ● Quick Connectors

- Used for 100 W to 300 W servo drives.
- One operating lever is provided for wire to terminal block insertion.



### ● Power Cables

- 3m and 5m standard cables are available.
- Customized service is offered to meet the needs of customers.
- Two types are selectable: with brake and without brake.



### ● Encoder Cables

- 3m and 5m standard cables are available.
- Customized service is offered to meet the needs of customers.



### ● RS-232 Communication Cables

- Connects ASDA-A2 to PLC, HMI and other controllers via RS-232 communication.
- Standard cable length is 3m



### ● CN1 I/O connector

- Delta Part Number: ASD-IF-SC5020

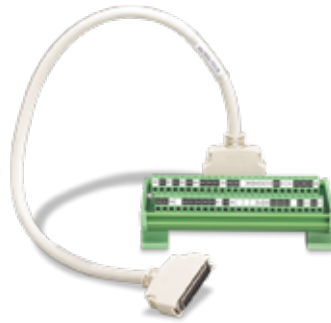

### ● Terminal Block Modules

- Easy installation and wiring.
- 0.5m connection cable is provided. Easy to reduce the space required.
- Easy to expand system's I/O configuration.

### ● Regenerative Resistors

- For selecting a regenerative resistor, please refer to the table of regenerative resistor specifications on page 70.

### ● USB Communication Cables (for PC)

- USB Communication Cables (for PC)
- USB1.1 is equipped as standard.



### ● CANopen Accessories

- Delta's TAP-CN03 distribution box connects ASDA-A2 to Delta's PLC CAN Master
- CANopen communication cable is provided



### ● RS-485 Connectors



- Used to connect multiple ASDA-A2 series products by RS-485 interface through Modbus serial communication.



Note: The figures are for illustration purposes only. Actual models may differ slightly in appearance to illustrations provided.

# Servo Drive Specifications



## 220 V Series

ASDA-A2 Series		100 W	200 W	400 W	750 W	1 kW	1.5 kW	2 kW	3 kW	4.5 kW	5.5 kW	7.5 kW	11 kW	15kW	
		01	02	04	07	10	15	20	30	45	55	75	1B	1F	
Power	Phase / Voltage	Three-phase / Single-phase 220 V <sub>AC</sub>						3-phase 220 V <sub>AC</sub>							
	Permissible Voltage Range	1-phase / 3-phase 200 ~ 230 V <sub>AC</sub> , -15% ~ 10%						3-phase 200 ~ 230 V <sub>AC</sub> , -15% ~ 10%							
	Input Current (3PH) (Units: Arms)	0.8	1.11	1.86	3.66	4.68	6.33	8.76	9.83	17.5	19.4	26.3	48	63	
	Input Current (1PH) (Units: Arms)	1	1.92	3.22	6.78	8.88	10.96	-	-	-	-	-	-	-	
Continuous Output Current (Units: Arms)		0.9	1.55	2.6	5.1	7.3	8.86	13.4	19.4	32.5	40	47.5	54.4	70	
Cooling System		Natural Air Circulation						Fan Cooling							
Encoder Resolution / Feedback Resolution		Incremental encoder: 20-bit ; Absolute encoder: 17-bit													
Control of Main Circuit		SVPWM (Space Vector Pulse Width Modulation) Control													
Tuning Modes		Auto / Manual													
Regenerative Resistor		None						Built-in				External			
Position Control Mode	Max. Input Pulse Frequency (Only for Non-DMCNET mode)	Max. 500Kpps / 4Mpps (Line driver), Max. 200Kpps (Open collector)													
	Pulse Type (Only for Non-DMCNET mode)	Pulse + Direction, A phase + B phase, CCW pulse + CW pulse													
	Command Source	External pulse train (PT mode) (Only for Non-DMCNET mode) / Internal parameters (PR mode)													
	Smoothing Strategy	Low-pass and P-curve filter													
	Electronic Gear	Electronic gear N/M multiple N: 1 ~ 32767, M: 1 : 32767 (1/50 < N/M < 25,600)													
	Torque Limit Operation	Set by parameters													
Feed Forward Compensation		Set by parameters													
Speed Control Mode	Analog Input Command (Only for Non-DMCNET mode)	Voltage Range	0 ~ ±10 V <sub>DC</sub>												
		Input Resistance	10KΩ												
		Time Constant	354.6 μs												
	Speed Control Range *1		1 : 5,000						1 : 3,000			1 : 2,000			
	Command Source		External analog signal (Only for Non-DMCNET mode) / Internal parameters												
	Smoothing Strategy		Low-pass and S-curve filter												
Torque Limit Operation		Set by parameters via analog input (Only for Non-DMCNET mode)													
Frequency Response Characteristic		Maximum 1kHz													
Speed Accuracy*2 (At rated rotation speed)		0.01% or less at 0 to 100% load fluctuation													
		0.01% or less at ±10% power fluctuation													
		0.01% or less at 0°C to 50°C ambient temperature fluctuation													
Torque Control Mode	Analog Input Command (Only for Non-DMCNET mode)	Voltage Range	0 ~ ±10 V <sub>DC</sub>												
		Input Resistance	10KΩ												
		Time Constant	2.2 μs												
	Command Source		External analog signal (Only for Non-DMCNET mode) / Internal parameters												
	Smoothing Strategy		Low-pass filter												
Speed Limit Operation		Set by parameters via analog input (Only for Non-DMCNET mode)													
Analog Monitor Output		Monitor signal can set by parameters (Output voltage range: ±8V)													
Digital Inputs / Outputs	Inputs	Servo on, Reset, Gain switching, Pulse clear, Zero speed CLAMP, Command input reverse control, Command triggered, Speed/Torque limit enabled, Position command selection, Motor stop, Speed position selection, Position/Speed mode switching, Speed/Torque mode switching, Torque/Position mode switching, PT/PR command switching, Emergency stop, Forward/Reverse inhibit limit, Reference "Home" sensor, Forward/Reverse operation torque limit, Move to "Home", Electronic Cam (E-CAM), Forward/Reverse JOG input, Event trigger PR command, Electronic gear ratio (Numerator) selection and Pulse inhibit input  * Please note that the above digital signals and inputs are available only for Non-DMCNET mode. In DMCNET mode, it is recommended to write digital inputs into the servo drives through DMCNET communication, and the digital inputs should be used for Emergency Stop, Forward / Reverse Inhibit limit and Reference "Home" sensor only.													
	Outputs	Encoder signal output (A, B, Z Line Driver and Z Open Collector) Servo ready, Servo on, At Zero speed, At Speed reached, At Positioning completed, At Torques limit, Servo alarm (Servo fault) activated, Electromagnetic brake control, Homing completed, Output overload warning, Servo warning activated, Position command overflow, Forward / Reverse software limit, Internal position command completed, Capture operation completed output., Motion control completed output., Master position of E-CAM (Electronic CAM)													
Protective Functions		Overcurrent, Overvoltage, Undervoltage, Motor overheated, Regeneration error, Overload, Overspeed, Abnormal pulse control command, Excessive deviation, Encoder error, Adjustment error, Emergency stop activated, Reverse/ Forward limit switch error, Position excessive deviation of full-close control loop, Serial communication error, Input power phase loss, Serial communication time out, short circuit protection of U, V, W, and CN1, CN2, CN3 terminals													
Communication Interface		RS-232 / RS-485 / CANopen / USB / DMCNET													
Environment	Installation Site		Indoor location (free from direct sunlight), no corrosive liquid and gas (far away from oil mist, flammable gas, dust)												
	Altitude		Altitude 2000m or lower above sea level												
	Atmospheric Pressure		86kPa ~ 106kPa												
	Operating Temperature		0°C ~ 55°C (If operating temperature is above 45°C, forced cooling will be required)												
	Storage Temperature		-20°C ~ 65°C												
	Humidity		0 ~ 90% RH (non-condensing)												
	Vibration		9.80665 m/s <sup>2</sup> (1G) less than 20Hz, 5.88 m/s <sup>2</sup> (0.6G) 20 to 50Hz												
IP Rating		IP20													
Power System		TN System*3													
Approvals		IEC/EN 61800-5-1, UL 508C, C-tick   US LISTED 													

**Footnote:**

- \*1. Rated rotation speed: When full load, speed ratio is defined as the minimum speed (the motor will not pause).
- \*2. When command is rated rotation speed, the speed fluctuation rate is defined as: (Empty load rotation speed / Full load rotation speed) / Rated rotation speed
- \*3. TN system: A power distribution system having one point directly earthed, the exposed conductive parts of the installation being connected to that points by protective earth conductor.

## 400 V Series

ASDA-A2 Series		750 W	1kW	1.5kW	2kW	3kW	4.5kW	5.5kW	7.5kW	11 kW	15 kW	
		07	10	15	20	30	45	55	75	1B	1F	
Control Power	Input Voltage	24 V <sub>DC</sub> ±10%										
	Input Current	0.89A				1.18A			1.66A	2A		
	Input Power	21.4 W				28.2 W			39.85W	48 W		
Main Power	Permissible Voltage Range	3-phase 380 ~ 480 V <sub>AC</sub> ±10%										
	Input Current (Units: Arms)	2.22	3.02	4.24	5.65	8.01	11.9	14.1	17.27	28.95	39.47	
	Continuous Output Current (Units: Arms)	3.07	3.52	5.02	6.66	11.9	20	22.37	30	28.1	38.65	
Cooling System		Fan Cooling										
Encoder Resolution / Feedback Resolution		Incremental encoder: 20-bit ; Absolute encoder: 17-bit										
Control of Main Circuit		SVPWM(Space Vector Pulse Width Modulation) Control										
Tuning Modes		Auto / Manual										
Regenerative Resistor		Built-in					External					
Position Control Mode	Max. Input Pulse Frequency <small>(Only for Non-DMCNET mode)</small>	Max. 500Kpps / 4Mpps (Line driver), Max. 200Kpps (Open collector)										
	Pulse Type <small>(Only for Non-DMCNET mode)</small>	Pulse + Direction, A phase + B phase, CCW pulse + CW pulse										
	Command Source	External pulse train <small>(Only for Non-DMCNET mode)</small> / Internal parameters										
	Smoother Strategy	Low-pass and P-curve filter										
	Electronic Gear	Electronic gear N/M multiple N: 1 ~ 32767, M: 1 : 32767 (1/50 < N/M < 25,600)										
	Torque Limit Operation	Set by parameters										
	Feed Forward Compensation	Set by parameters										
Speed Control Mode	Analog Input Command <small>(Only for Non-DMCNET mode)</small>	Voltage Range		0 ~ ±10 V <sub>DC</sub>								
		Input Resistance		10KΩ								
		Time Constant		2.2 μs								
	Speed Control Range *1	1 : 5,000					1 : 3,000					
	Command Source	External analog signal <small>(Only for Non-DMCNET mode)</small> / Internal parameters										
	Smoother Strategy	Low-pass and S-curve filter										
	Torque Limit Operation	Set by parameters or via analog input <small>(Only for Non-DMCNET mode)</small>										
Frequency Response Characteristic	Maximum 1kHz											
	0.01% or less at 0 to 100% load fluctuation											
	0.01% or less at ±10% power fluctuation											
Speed Accuracy *2	0.01% or less at 0°C to 50°C ambient temperature fluctuation											
Torque Control Mode	Analog Input Command <small>(Only for Non-DMCNET mode)</small>	Voltage Range		0 ~ ±10 V <sub>DC</sub>								
		Input Resistance		10KΩ								
		Time Constant		2.2 μs								
	Command Source	External analog signal <small>(Only for Non-DMCNET mode)</small> / Internal parameters										
Smoother Strategy	Low-pass filter											
Speed Limit Operation	Set by parameters or via analog input <small>(Only for Non-DMCNET mode)</small>											
Analog Monitor Output		Monitor signal can set by parameters (Output voltage range: ±8V)										
Digital Inputs / Outputs	Inputs	Servo on, Reset, Gain switching, Pulse clear, Zero speed CLAMP, Command input reverse control, Command triggered, Speed / Torque limit enabled, Position command selection, Motor stop, Speed position selection, Position / Speed mode switching, Speed / Torque mode switching, Torque / Position mode switching, PT / PR command switching, Emergency stop, Forward / Reverse inhibit limit, Reference "Home" sensor, Forward / Reverse operation torque limit, Move to "Home", Electronic cam, Forward / Reverse JOG input, Event trigger PR command, Electronic gear ratio (Numerator) selection and Pulse inhibit input  * Please note that the above digital signals and inputs are available only for Non-DMCNET mode. In DMCNET mode, it is recommended to write digital inputs into the servo drives through DMCNET communication, and the digital inputs should be used for Emergency Stop, Forward / Reverse Inhibit limit and Reference "Home" sensor only.										
	Outputs	Encoder signal output (A, B, Z Line Driver and Z Open Collector) Servo ready, Servo on, At Zero speed, At Speed reached, At Positioning completed, At Torques limit, Servo alarm (Servo fault) activated, Electromagnetic brake control, Homing completed, Output overload warning, Servo warning activated, Position command overflow, Forward / Reverse software limit, Internal position command completed, Capture operation completed output., Motion control completed output., Master position of E-CAM (Electronic CAM)										
Protective Functions		Overcurrent, Overvoltage, Undervoltage, Motor overheated, Regeneration error, Overload, Overspeed, Abnormal pulse control command, Excessive deviation, Encoder error, Adjustment error, Emergency stop activated, Reverse / Forward limit switch error, Position excessive deviation of full-close control loop, Serial communication error, Input power phase loss, Serial communication time out, short circuit protection of U, V, W, and CN1, CN2, CN3 terminals										
Communication Interface		RS-232 / RS-485 / CANopen / USB / DMCNET										
Environment	Installation Site	Indoor location (free from direct sunlight), no corrosive liquid and gas (far away from oil mist, flammable gas, dust)										
	Altitude	Altitude 2000m or lower above sea level										
	Atmospheric Pressure	86kPa ~ 106kPa										
	Operating Temperature	0°C ~ 55°C (If operating temperature is above 45°C, forced cooling will be required)										
	Storage Temperature	-20°C ~ 65°C										
	Humidity	0 ~ 90% RH (non-condensing)										
	Vibration	9.80665 m/s <sup>2</sup> (1G) less than 20Hz, 5.88 m/s <sup>2</sup> (0.6G) 20 to 50Hz										
	IP Rating	IP20										
Power System	TN System*3											
Approvals	IEC/EN 61800-5-1, UL 508C, C-tick   											

### Footnote:

\*1. Rated rotation speed: When full load, speed ratio is defined as the minimum speed (the motor will not pause).

\*2. When command is rated rotation speed, the speed fluctuation rate is defined as: (Empty load rotation speed / Rated rotation speed) / Rated rotation speed

\*3. TN system: A power distribution system having one point directly earthed, the exposed conductive parts of the installation being connected to that points by protective earth conductor.

# Servo Drive Dimensions

## 220V Series

Units: mm (inches)

100W / 200W / 400W

Weight
1.5 (3.3)

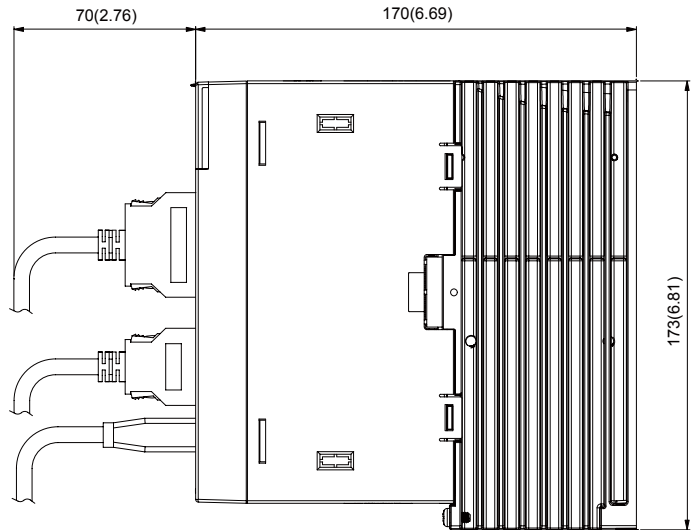
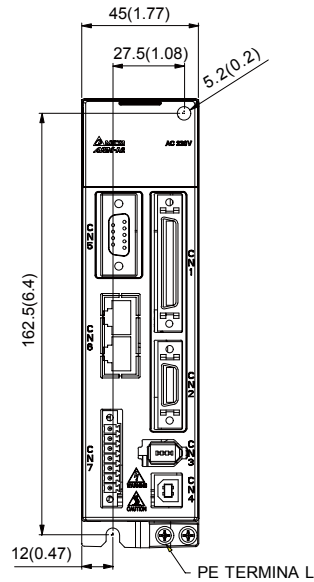

750W / 1.0kW / 1.5kW

Weight
2.0 (4.4)

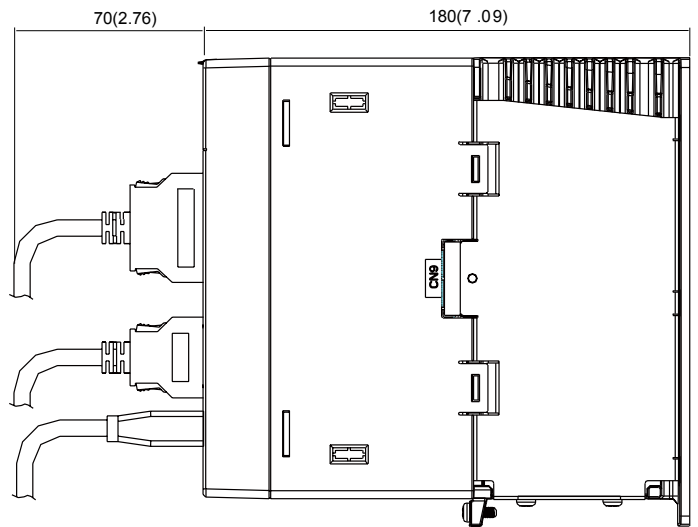
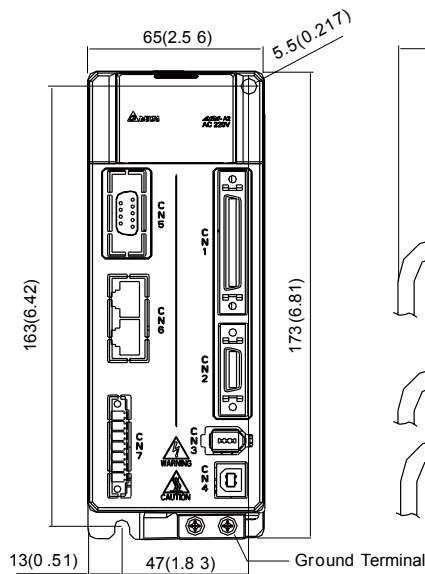

**NOTE**

- 1) Dimensions are in millimeters (inches); Weights are in kilograms (kg) and (pounds (lbs)).
- 2) Dimensions and weights of the servo drive may be revised without prior notice.

## 2.0kW / 3.0kW

<b>Weight</b>
2.89 (6.36)

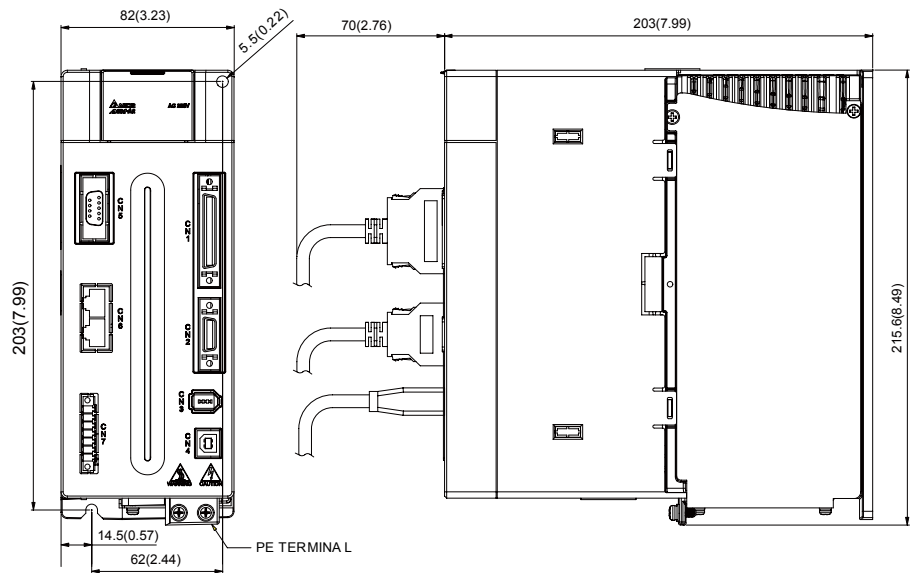

## 4.5kW

<b>Weight</b>
4.4 (10.0)

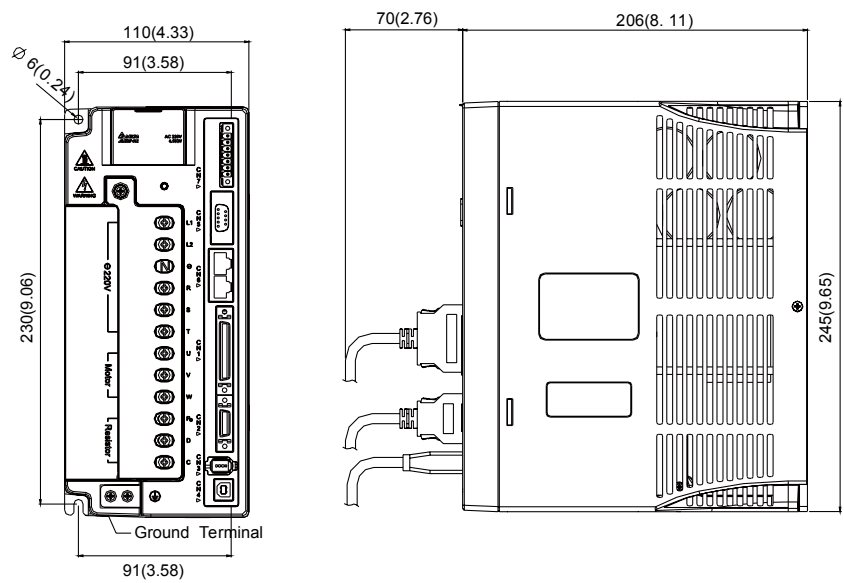

### NOTE

- 1) Dimensions are in millimeters (inches); Weights are in kilograms (kg) and (pounds (lbs)).
- 2) Dimensions and weights of the servo drive may be revised without prior notice.

# Servo Drive Dimensions

Units: mm (inches)

## 220V Series

5.5kW

Weight
5.5 (12.1)

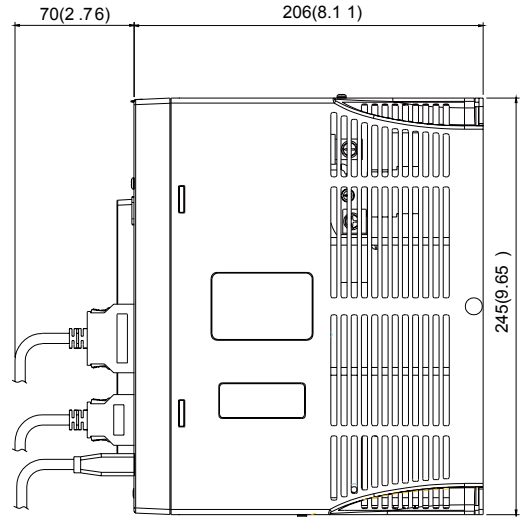
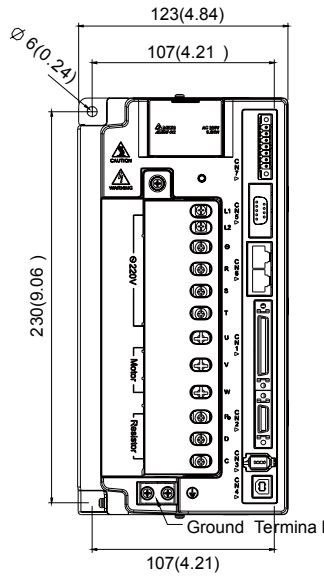

7.5kW

Weight
5.9 (13)

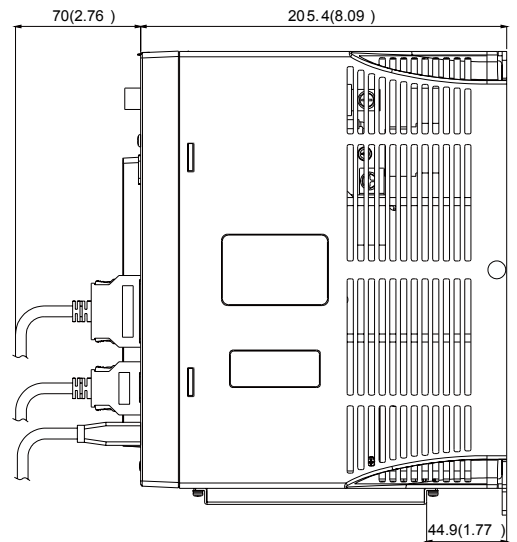
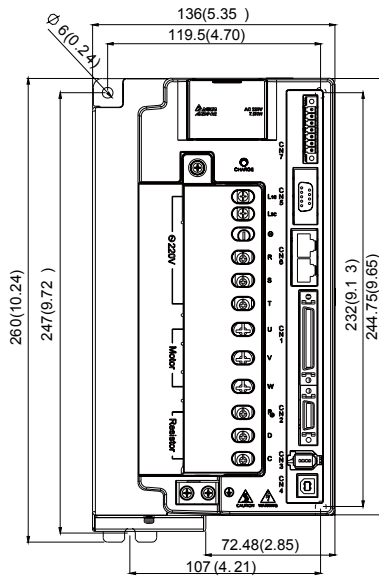

**NOTE**

- 1) Dimensions are in millimeters (inches); Weights are in kilograms (kg) and (pounds (lbs)).
- 2) Dimensions and weights of the servo drive may be revised without prior notice.



11kW / 15kW

<b>Weight</b>
20 (44)

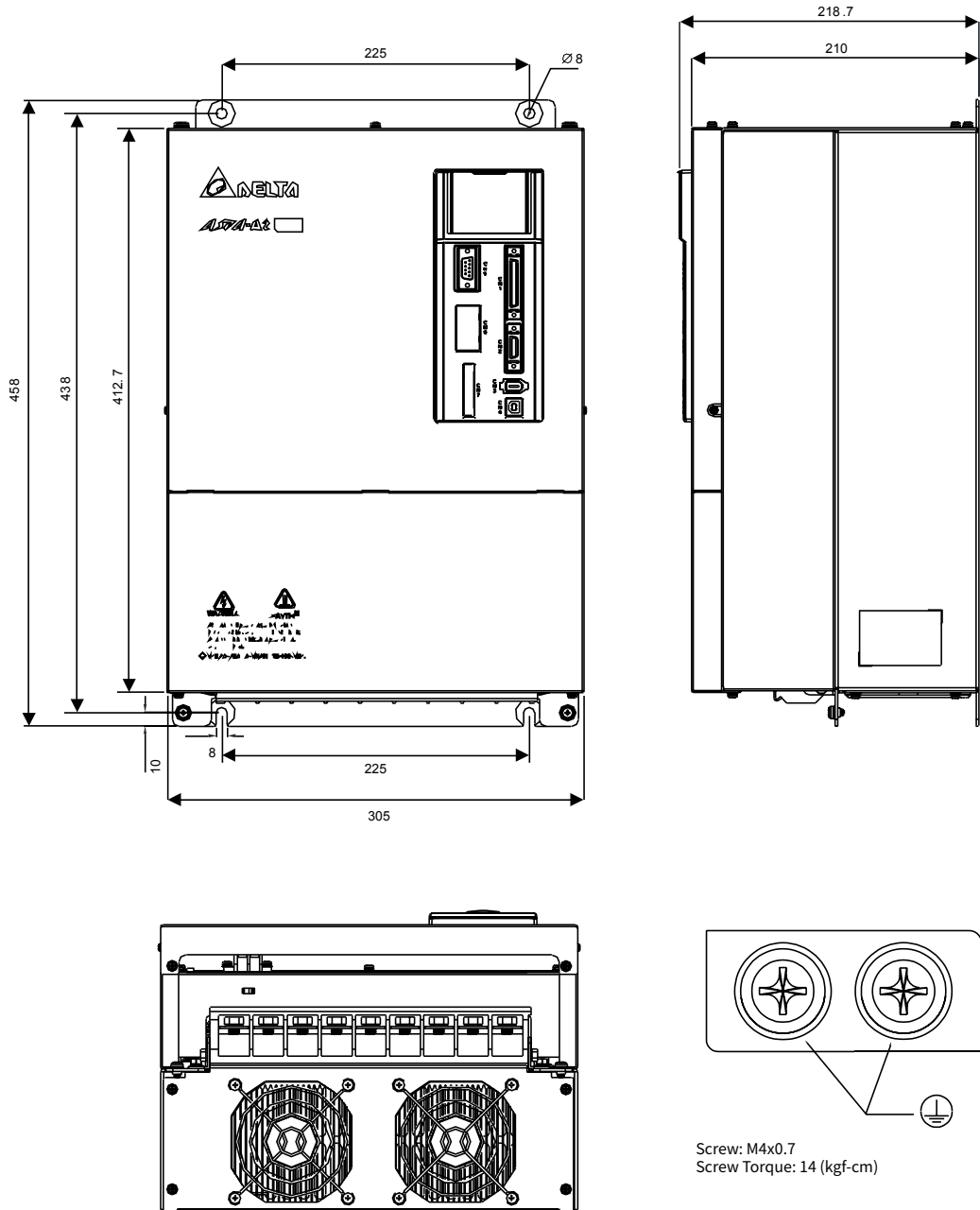

**NOTE**

- 1) Dimensions are in millimeters (inches); Weights are in kilograms (kg) and (pounds (lbs)).
- 2) Dimensions and weights of the servo drive may be revised without prior notice.

# Servo Drive Dimensions

Units: mm (inches)

## 400 V Series

750W / 1.0kW / 1.5kW

Weight
2.89 (6.36)

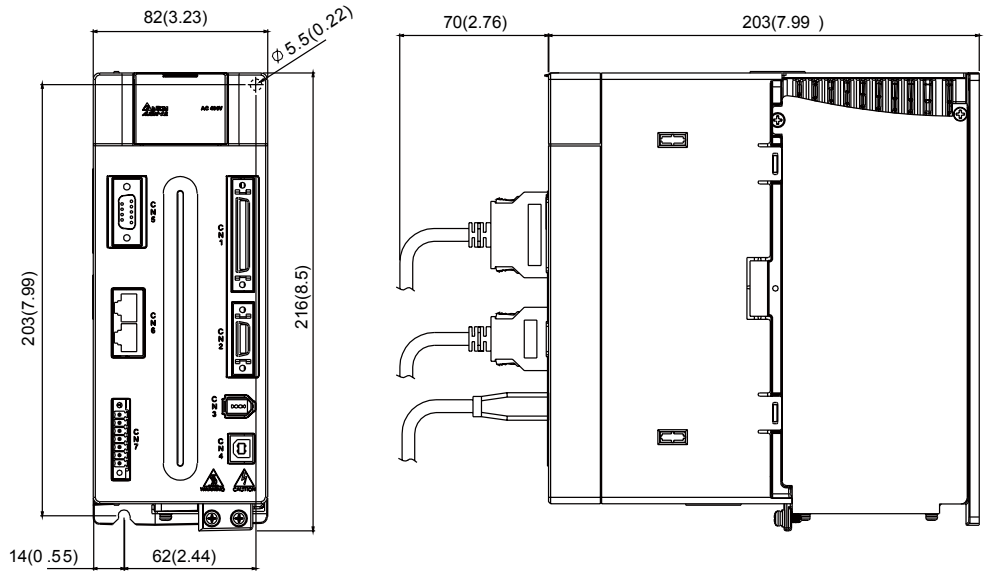

2.0kW / 3.0kW / 4.5kW / 5.5kW

Weight
5.5 (12.1)

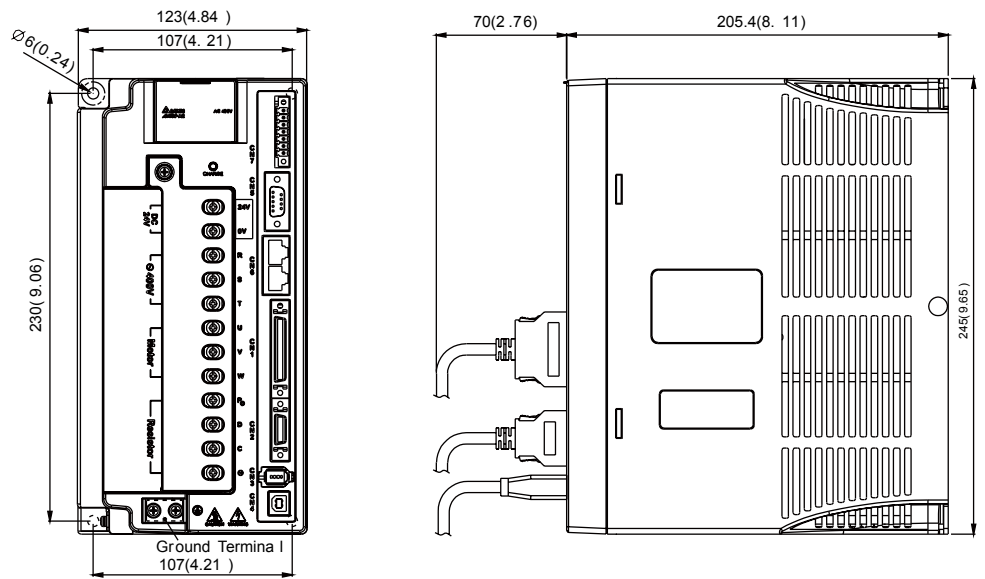

### NOTE

- 1) Dimensions are in millimeters (inches); Weights are in kilograms (kg) and (pounds (lbs)).
- 2) Dimensions and weights of the servo drive may be revised without prior notice.

7.5kW

**Weight**  
5.5 (12.1)

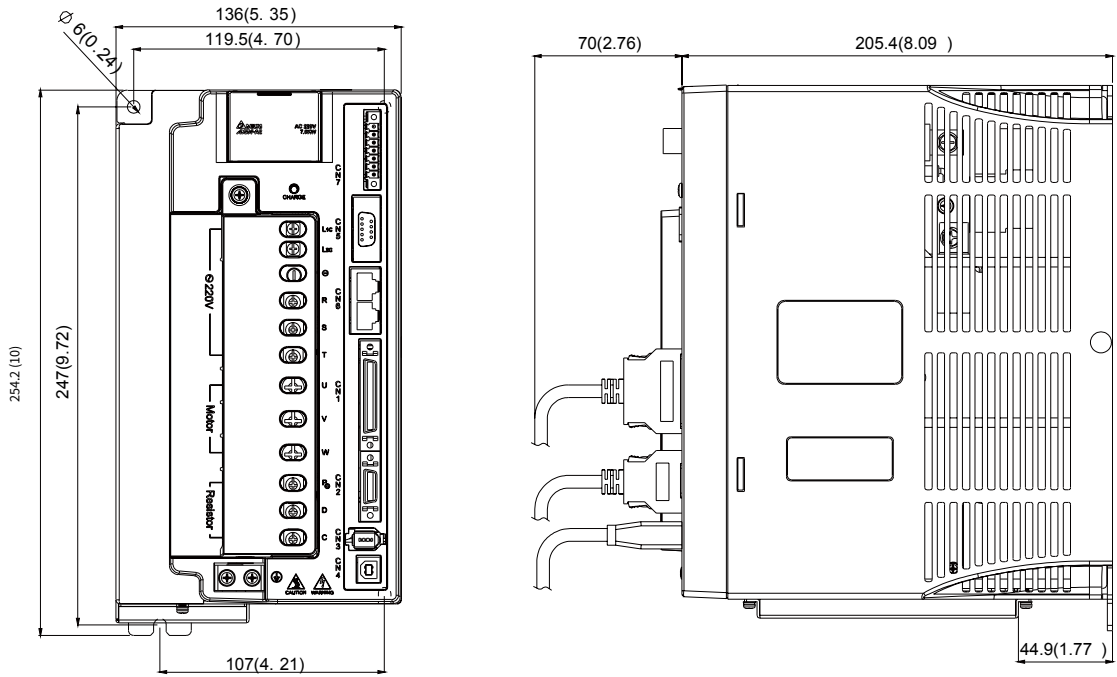

11kW / 15kW

**Weight**  
10.3(22.66)

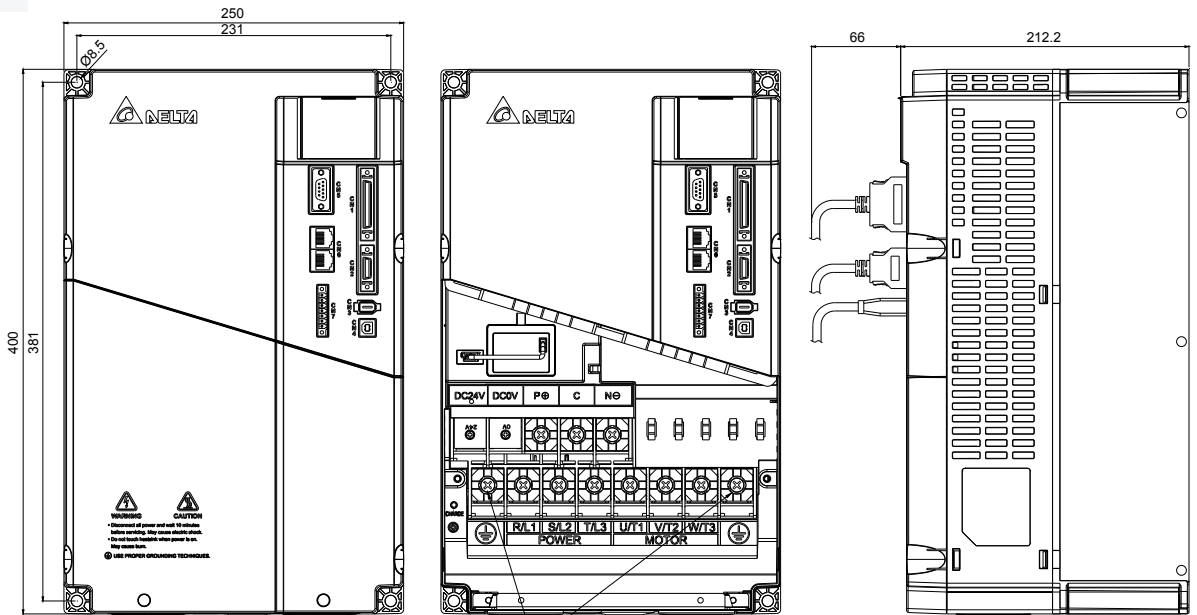

**NOTE**

- 1) Dimensions are in millimeters (inches); Weights are in kilograms (kg) and (pounds (lbs)).
- 2) Dimensions and weights of the servo drive may be revised without prior notice.

# Optional Cables and Connectors

## ● Power Connectors

ASDBCAPW0000 (for 200 V drives)

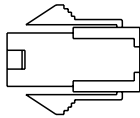

ASD-CAPW1000

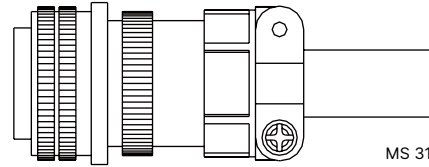
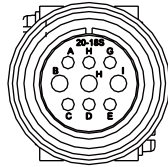

MS 3106A-20-18S

ASDBCAPW0100 (for 200 V drives, with brake cable)

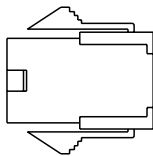

ASD-CAPW2000

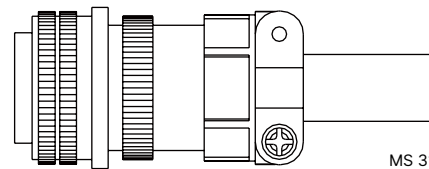
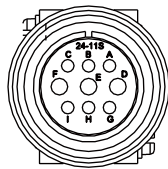

MS 3106A-24-11S

ASD-CAPW5400 (for 400 V drives)

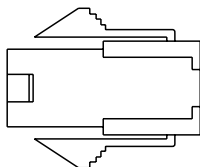

ASD-CAPW4000

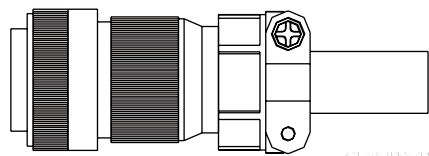
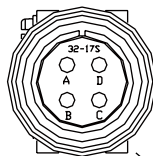

Straight Plug WPS3106A-32-17S

CLAMP: WPS3057-20A

ASD-CAPW5100 (for 400 V drives, with brake cable)

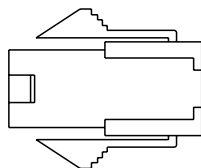

ASD-CNBR1000

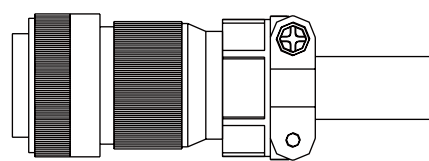
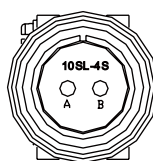

CLAMP: WPS3106A 10SL-4S-R

## ● Power Cables

ASD-ABPW0003, ASD-ABPW0005 (for 200 V drives)

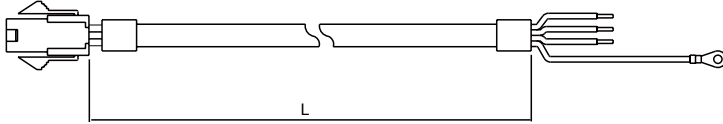

Item	Part No.	L	
		mm	inch
1	ASD-ABPW0003	3,000 ± 100	118 ± 4
2	ASD-ABPW0005	5,000 ± 100	197 ± 4

ASD-CAPW5403, ASD-CAPW5405 (for 400 V drives)

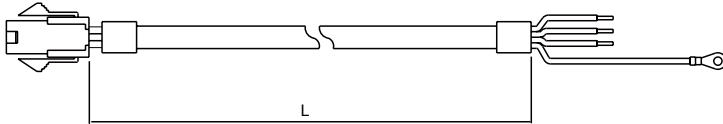

Item	Part No.	L	
		mm	inch
1	ASD-CAPW5403	3,000 ± 100	118 ± 4
2	ASD-CAPW5405	5,000 ± 100	197 ± 4

AASD-ABPW0103, ASD-ABPW0105 (for 200 V drives, with brake cable)

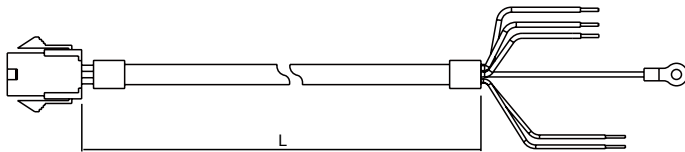

Item	Part No.	L	
		mm	inch
1	ASD-ABPW0103	3,000 ± 100	118 ± 4
2	ASD-ABPW0105	5,000 ± 100	197 ± 4

ASD-CAPW5103, ASD-CAPW5105 (for 400 V drives, with brake cable)

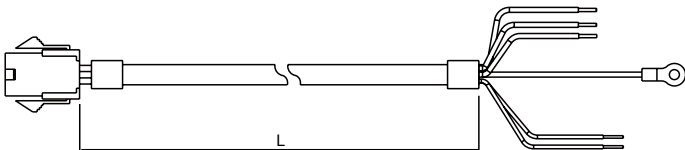

Item	Part No.	L	
		mm	inch
1	ASD-CAPW5103	3,000 ± 100	118 ± 4
2	ASD-CAPW5105	5,000 ± 100	197 ± 4

ASD-CAPW1003, ASD-CAPW1005

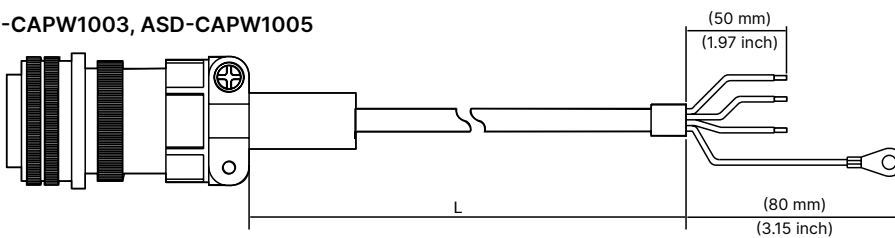

Item	Part No.	Straight	L	
			mm	inch
1	ASD-CAPW1003	3106A-20-18S	3,000 ± 100	118 ± 4
2	ASD-CAPW1005	3106A-20-18S	5,000 ± 100	197 ± 4

# Optional Cables and Connectors

## ● Power Cables

ASD-CAPW1103, ASD-CAPW1105 (with brake cable)

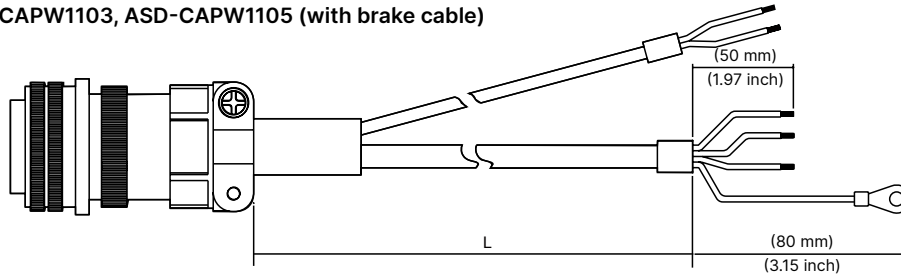

Item	Part No.	Straight	L	
			mm	inch
1	ASD-CAPW1103	3106A-20-18S	3,000 ± 100	118 ± 4
2	ASD-CAPW1105	3106A-20-18S	5,000 ± 100	197 ± 4

ASDBCAPW1203, ASDBCAPW1205

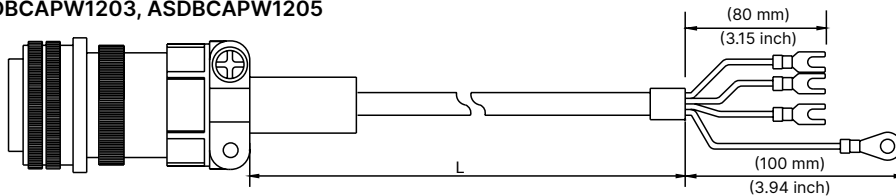

Item	Part No.	Straight	L	
			mm	inch
1	ASD-BCAPW1203	3106A-20-18S	3,000 ± 100	118 ± 4
2	ASDB-CAPW1205	3106A-20-18S	5,000 ± 100	197 ± 4

ASD-CAPW1303, ASD-CAPW1305 (with brake cable)

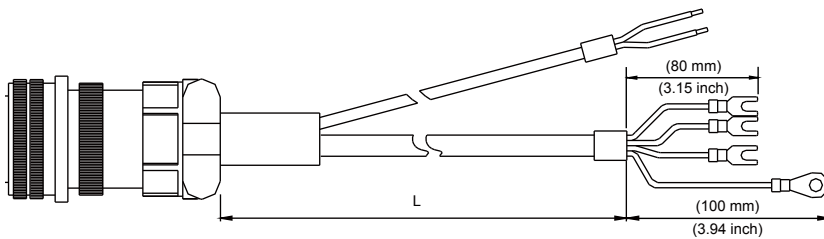

Item	Part No.	Straight	L	
			mm	inch
1	ASD-CAPW1303	3106A-20-18S	3,000 ± 100	118 ± 4
2	ASD-CAPW1305	3106A-20-18S	5,000 ± 100	197 ± 4

ASD-A2PW1003, ASD-A2PW1005

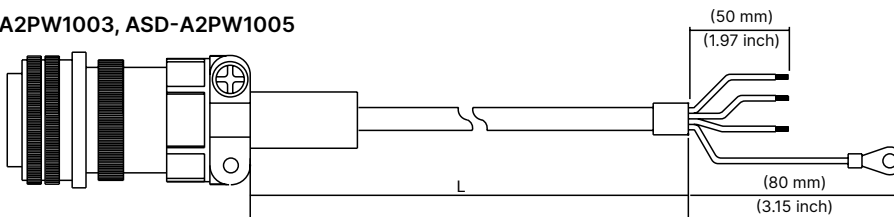

Item	Part No.	Straight	L	
			mm	inch
1	ASD-A2PW1003	3106A-20-18S	3,000 ± 100	118 ± 4
2	ASD-A2PW1005	3106A-20-18S	5,000 ± 100	197 ± 4

## ● Power Cables

ASD-A2PW1103, ASD-A2PW1105 (with brake cable)

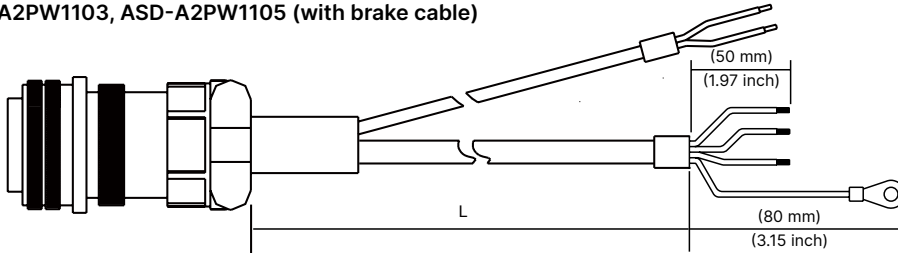

Item	Part No.	Straight	L	
			mm	inch
1	ASD-A2PW1103	3106A-20-18S	3,000 ± 100	118 ± 4
2	ASD-A2PW1105	3106A-20-18S	5,000 ± 100	197 ± 4

ASD-CAPW2003, ASD-CAPW2005

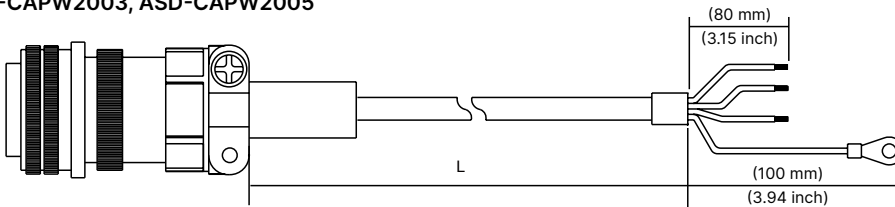

Item	Part No.	Straight	L	
			mm	inch
1	ASD-CAPW2003	3106A-24-11S	3,000 ± 100	118 ± 4
2	ASD-CAPW2005	3106A-24-11S	5,000 ± 100	197 ± 4

ASD-CAPW2103, ASD-CAPW2105 (with brake cable)

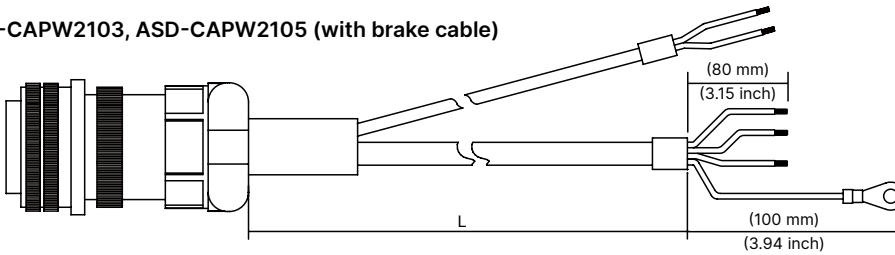

Item	Part No.	Straight	L	
			mm	inch
1	ASD-CAPW2103	3106A-24-11S	3,000 ± 100	118 ± 4
2	ASD-CAPW2105	3106A-24-11S	5,000 ± 100	197 ± 4

ASD-CAPW2203, ASD-CAPW2205

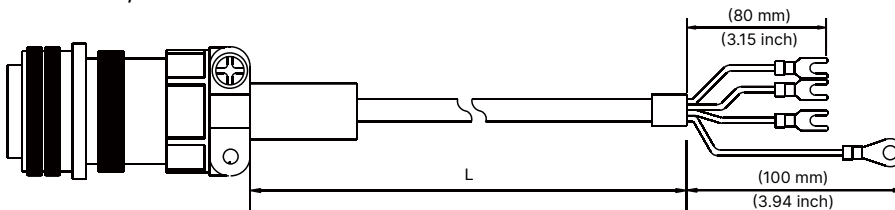

Item	Part No.	Straight	L	
			mm	inch
1	ASD-CAPW2203	3106A-24-11S	3,000 ± 100	118 ± 4
2	ASD-CAPW2205	3106A-24-11S	5,000 ± 100	197 ± 4

# Optional Cables and Connectors

## ● Power Cables

ASD-CAPW2303, ASD-CAPW2305 (with brake cable)

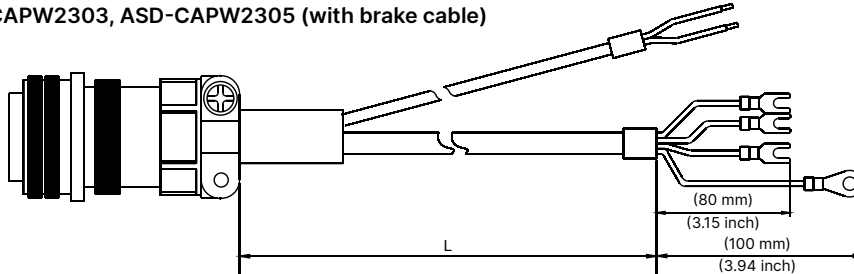

Item	Part No.	Straight	L	
			mm	inch
1	ASD-CAPW2303	3106A-24-11S	3,000 ± 100	118 ± 4
2	ASD-CAPW2305	3106A-24-11S	5,000 ± 100	197 ± 4

ASD-CAPW3203 , ASD-CAPW3205

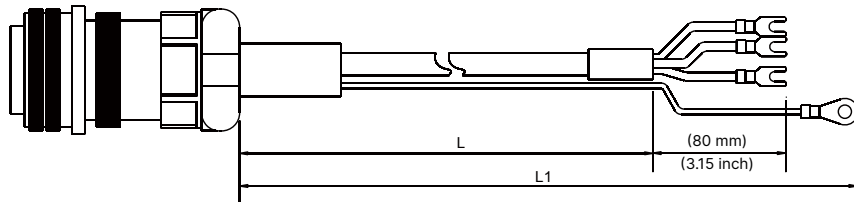

Item	Part No.	Straight	L		L1	
			mm	inch	mm	inch
1	ASD-CAPW3203	3106A-24-11S	3,000 ± 100	118 ± 4	3,100 ± 100	122 ± 4
2	ASD-CAPW3205	3106A-24-11S	5,000 ± 100	197 ± 4	5,100 ± 100	201 ± 4

ASD-CAPW3303 , ASD-CAPW3305 (with brake cable)

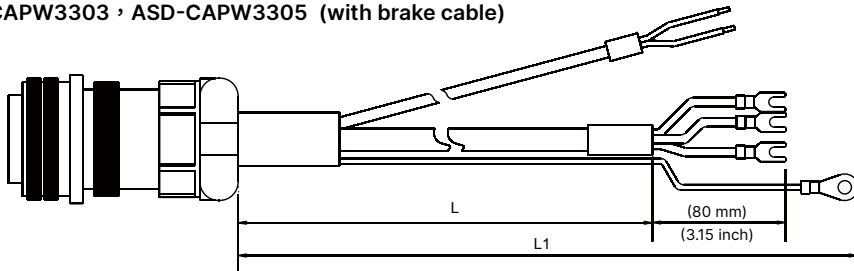

Item	Part No.	Straight	L		L1	
			mm	inch	mm	inch
1	ASD-CAPW3303	3106A-24-11S	3,000 ± 100	118 ± 4	3,100 ± 100	122 ± 4
2	ASD-CAPW3305	3106A-24-11S	5,000 ± 100	197 ± 4	5,100 ± 100	201 ± 4

ASD-CAPW4503, ASD-CAPW4505

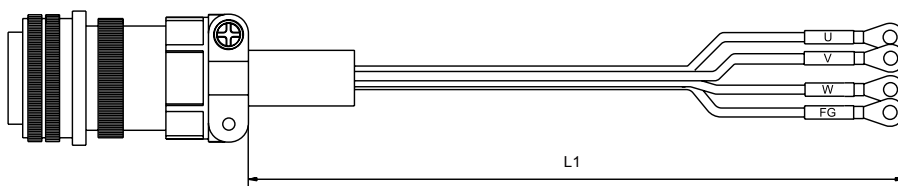

Item	Part No.	Straight	L	
			mm	inch
1	ASD-CAPW4503	3106A-32-17S	3,100 ± 100	122 ± 4
2	ASD-CAPW4505	3106A-32-17S	5,100 ± 100	201 ± 4



## ● Power Cables

### ASD-CAPW4703, ASD-CAPW4705 (with brake cable)

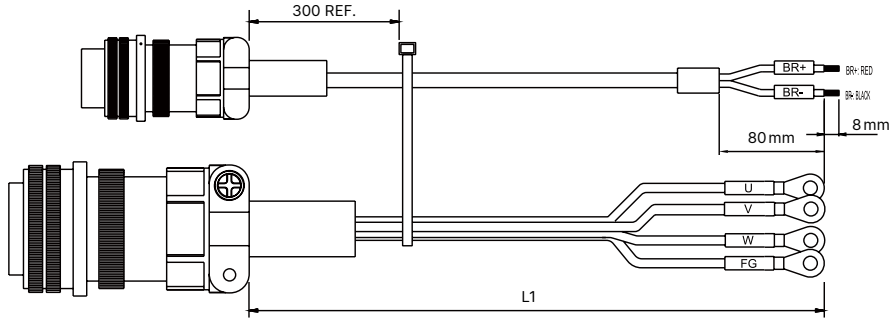

Item	Part No.	Straight	L	
			mm	inch
1	ASD-CAPW4703	3106A-32-17S	3,100 ± 100	122 ± 4
		3106A-10SL-4S	3,100 ± 100	122 ± 4
2	ASD-CAPW4705	3106A-32-17S	5,100 ± 100	201 ± 4
		3106A-10SL-4S	5,100 ± 100	201 ± 4

### ASD-CAPW4603, ASD-CAPW4605



Item	Part No.	Straight	L	
			mm	inch
1	ASD-CAPW4603	3106A-32-17S	3,100 ± 100	122 ± 4
2	ASD-CAPW4605	3106A-32-17S	5,100 ± 100	201 ± 4

### ASD-CAPW4803, ASD-CAPW4805 (with brake cable)

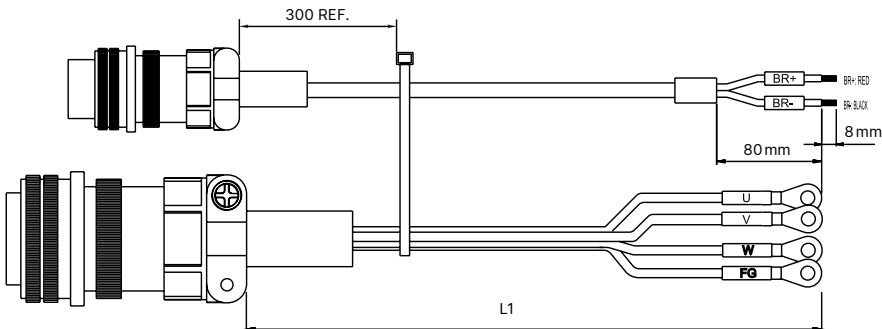

Item	Part No.	Straight	L	
			mm	inch
1	ASD-CAPW4803	3106A-32-17S	3,100 ± 100	122 ± 4
		3106A-10SL-4S	3,100 ± 100	122 ± 4
2	ASD-CAPW4805	3106A-32-17S	5,100 ± 100	201 ± 4
		3106A-10SL-4S	5,100 ± 100	201 ± 4

# Optional Cables and Connectors

## Encoder Connectors

ASD-ABEN0000

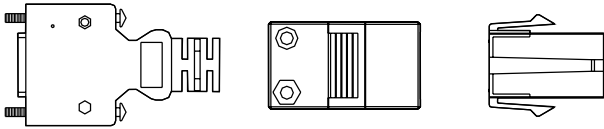

## Encoder Connectors

ASD-CAEN1000

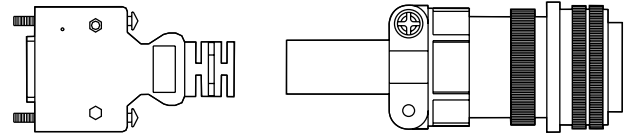

## Incremental Encoder Cables

ASD-ABEN0003 · ASD-ABEN0005

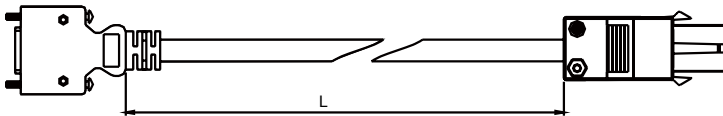

Item	Part No.	L	
		mm	inch
1	ASD-ABEN0003	3,000 ± 100	118 ± 4
2	ASD-ABEN0005	5,000 ± 100	197 ± 4

ASD-CAEN1003 · ASD-CAEN1005

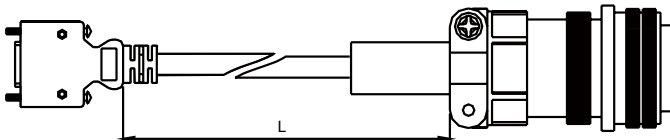

Item	Part No.	Straight	L	
			mm	inch
1	ASD-CAEN1003	3106A-20-29S	3,000 ± 100	118 ± 4
2	ASD-CAEN1005	3106A-20-29S	5,000 ± 100	197 ± 4

## Absolute Encoder Cables

ASD-A2EB0003 · ASD-A2EB0005

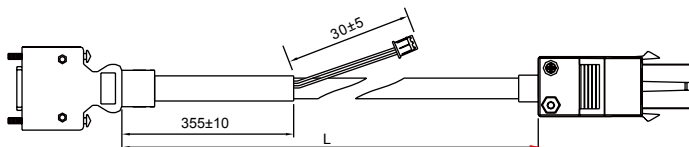

Item	Part No.	L	
		mm	inch
1	ASD-A2EB0003	3,000 ± 100	118 ± 4
2	ASD-A2EB0005	5000 ± 100	197 ± 4

ASD-A2EB1003 · ASD-A2EB1005

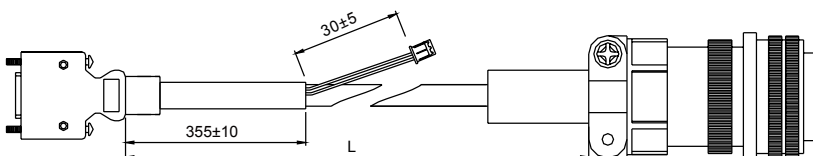

Item	Part No.	L	
		mm	inch
1	ASD-A2EB1003	3,000 ± 100	118 ± 4
2	ASD-A2EB1005	5,000 ± 100	197 ± 4

● **Battery Box Cord AW (Connects to the battery side of the encoder cable)** Units: mm

3864573700

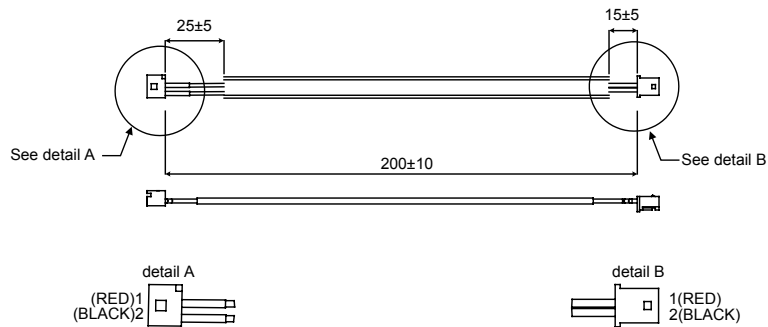

● **Battery Box Cord IW (Connects to CN8)** Units: mm

3864811900

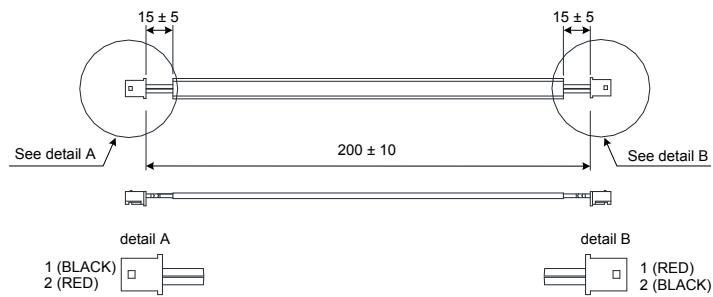

● **Battery Boxes with Batteries** Units: mm

Single Battery Box  
ASD-MDBT0100

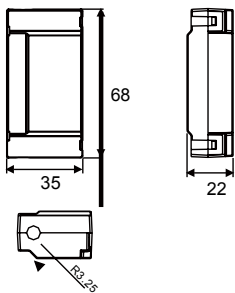

Dual Battery Box  
ASD-MDBT0200

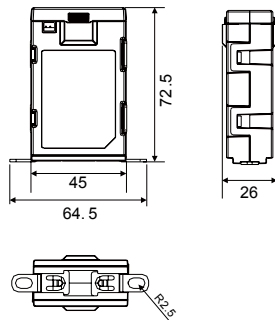

● **I/O Signal Connector (CN1)**

ASD-CN5C0050

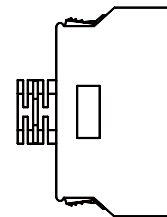

● **Terminal Block Module**

ASD-BM-50A

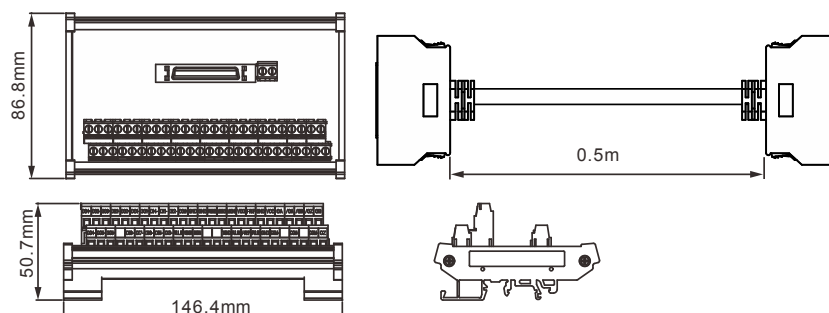

# Optional Cables and Connectors

## ● RS-232 Communication Cable

ASD-CARS0003

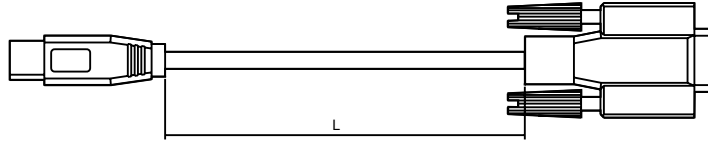

Item	Part No.	L	
		mm	inch
1	ASD-CARS0003	3,000 ± 100	118 ± 4

## ● Communication Cable between Drive and Computer (for PC)

DOP-CAUSBAB

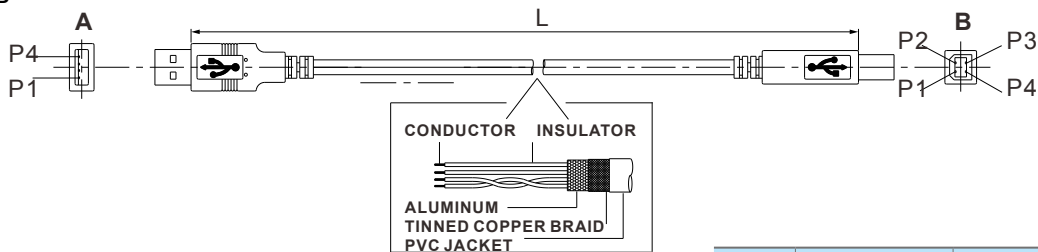

Item	Part No.	L	
		mm	inch
1	DOP-CAUSBAB	1,400 ± 30	55 ± 1.2

## ● CANopen Communication Cable

TAP-CB03 , TAP-CB05

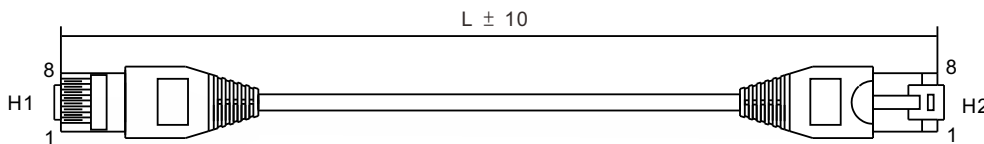

Item	Part No.	L	
		mm	inch
1	TAP-CB03	300±10	11±0.4
2	TAP-CB05	500±10	19±0.4

## ● CANopen Distribution Box Units: mm[inch]

TAP-CN03

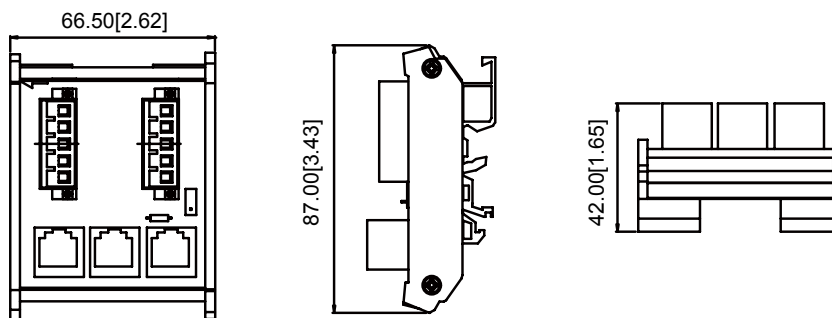

- 1) Other accessories for ASDA-A2 series will be increased gradually.
- 2) Accessories images shown here may differ from actual product appearance. Please refer to the actual product appearance.

● **RS-485 Connector** Units: mm[inch]

ASD-CNIE0B06

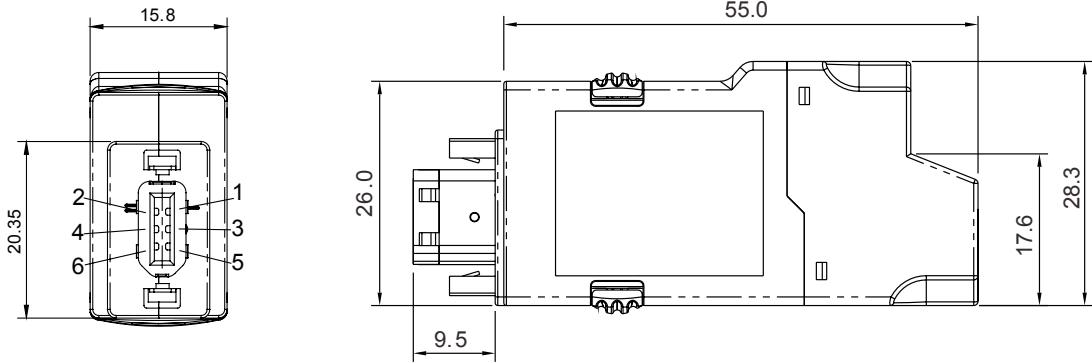

● **CN1 I/O Connector** Units: mm[inch]

ASD-IF-SC5020

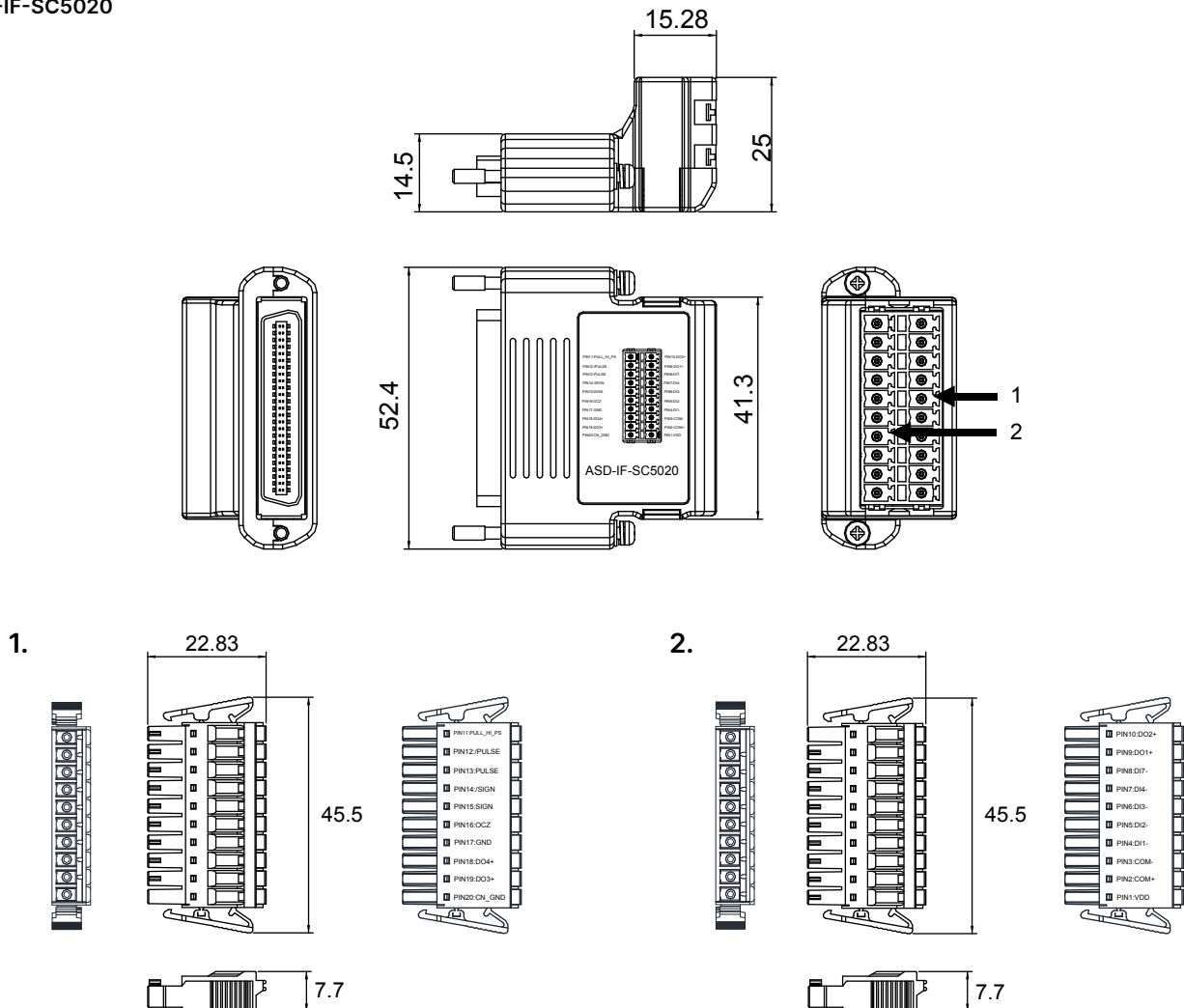

# Servo Drive, Servo Motor and Accessories Combinations

## 220 V Series

### 100W Servo Drive and 50W Low Inertia Servo Motor

Servo Drive	ASD-A2-0121- □
<b>Low Inertia Servo Motor</b>	<b>ECMA-C1040F □ S</b>
Power Cable (Without Brake)	ASD-ABPW000X
Power Connector (Without Brake)	ASDBCAPW0000
Power Cable (With Brake)	ASD-ABPW010X
Power Connectors (With Brake)	ASDBCAPW0100
Incremental Encoder Cable	ASD-ABEN000X
Absolute Encoder Cable	ASD-A2EB000X
Encoder Connectors	ASD-ABEN0000

(X=3 indicates cable length is 3m; X=5 indicates cable length is 5m)

### 100W Servo Drive and 100W Low Inertia Servo Motor

Servo Drive	ASD-A2-0121- □
<b>Low Inertia Servo Motor</b>	<b>ECMA-C △ 0401 □ S</b>
Power Cable (Without Brake)	ASD-ABPW000X
Power Connector (Without Brake)	ASDBCAPW0000
Power Cable (With Brake)	ASD-ABPW010X
Power Connectors (With Brake)	ASDBCAPW0100
Incremental Encoder Cable	ASD-ABEN000X
Absolute Encoder Cable	ASD-A2EB000X
Encoder Connectors	ASD-ABEN0000

(X=3 indicates cable length is 3m; X=5 indicates cable length is 5m)

### 200W Servo Drive and 200W Low Inertia Servo Motor

Servo Drive	ASD-A2-0221- □
<b>Low Inertia Servo Motor</b>	<b>ECMA-C △ 0602 □ S</b>
Power Cable (Without Brake)	ASD-ABPW000X
Power Connector (Without Brake)	ASDBCAPW0000
Power Cable (With Brake)	ASD-ABPW010X
Power Connector (With Brake)	ASDBCAPW0100
Incremental Encoder Cable	ASD-ABEN000X
Absolute Encoder Cable	ASD-A2EB000X
Encoder Connector	ASD-ABEN0000

(X=3 indicates cable length is 3m; X=5 indicates cable length is 5m)

### 400W Servo Drive and 400W Low Inertia Servo Motor

Servo Drive	ASD-A2-0421- □
<b>Low Inertia Servo Motor</b>	<b>ECMA-C △ 0604 □ S ECMA-C △ 0604 □ H ECMA-C △ 0804 □ 7</b>
Power Cable (Without Brake)	ASD-ABPW000X
Power Connector (Without Brake)	ASDBCAPW0000
Power Cable (With Brake)	ASD-ABPW010X
Power Connector (With Brake)	ASDBCAPW0100
Incremental Encoder Cable	ASD-ABEN000X
Absolute Encoder Cable	ASD-A2EB000X
Encoder Connector	ASD-ABEN0000

(X=3 indicates cable length is 3m; X=5 indicates cable length is 5m)

### 400W Servo Drive and 500W Medium Servo Motor

Servo Drive	ASD-A2-0421- □
<b>Medium Servo Motor</b>	<b>ECMA-E △ 1305 □ S</b>
Power Cable (Without Brake)	ASD-CAPW100X
Power Cable (With Brake)	ASD-CAPW110X
Power Connector	ASD-CAPW1000
Incremental Encoder Cable	ASD-CAEN100X
Absolute Encoder Cable	ASD-A2EB100X
Encoder Connector	ASD-CAEN1000

(X=3 indicates cable length is 3m; X=5 indicates cable length is 5m)

### 400W Servo Drive and 300W High Inertia Servo Motor

Servo Drive	ASD-A2-0421- □
<b>High Inertia Servo Motor</b>	<b>ECMA-G △ 1303 □ S</b>
Power Cable (Without Brake)	ASD-CAPW100X
Power Cable (With Brake)	ASD-CAPW110X
Power Connector	ASD-CAPW1000
Incremental Encoder Cable	ASD-CAEN100X
Absolute Encoder Cable	ASD-A2EB100X
Encoder Connector	ASD-CAEN1000

(X=3 indicates cable length is 3m; X=5 indicates cable length is 5m)

### 750W Servo Drive and 750W Low Inertia Servo Motor

Servo Drive	ASD-A2-0721- □
<b>Low Inertia Servo Motor</b>	<b>ECMA-C △ 0807 □ S</b> <b>ECMA-C △ 0807 □ H</b> <b>ECMA-C △ 0907 □ S</b>
Power Cable (Without Brake)	ASD-ABPW000X
Power Connector (Without Brake)	ASDBCAPW0000
Power Cable (With Brake)	ASD-ABPW010X
Power Connector (With Brake)	ASDBCAPW0100
Incremental Encoder Cable	ASD-ABEN000X
Absolute Encoder Cable	ASD-A2EB000X
Encoder Connector	ASD-ABEN0000

(X=3 indicates cable length is 3m; X=5 indicates cable length is 5m)

### 750W Servo Drive and 500W High Inertia Servo Motor

Servo Drive	ASD-A2-0721- □
<b>High Inertia Servo Motor</b>	<b>ECMA-F △ 1305 □ S</b>
Power Cable (Without Brake)	ASD-CAPW100X
Power Cable (With Brake)	ASD-CAPW110X
Power Connector (With Brake)	ASD-CAPW1000
Incremental Encoder Cable	ASD-CAEN100X
Absolute Encoder Cable	ASD-A2EB100X
Encoder Connector	ASD-CAEN1000

(X=3 indicates cable length is 3m; X=5 indicates cable length is 5m)

### 750W Servo Drive and 600W High Inertia Servo Motor

Servo Drive	ASD-A2-0721- □
<b>High Inertia Servo Motor</b>	<b>ECMA-G △ 1306 □ S</b>
Power Cable (Without Brake)	ASD-CAPW100X
Power Cable (With Brake)	ASD-CAPW110X
Power Connector	ASD-CAPW1000
Incremental Encoder Cable	ASD-CAEN100X
Absolute Encoder Cable	ASD-A2EB100X
Encoder Connector	ASD-CAEN1000

(X=3 indicates cable length is 3m; X=5 indicates cable length is 5m)

### 1kW Servo Drive and 1kW Low Inertia Servo Motor

Servo Drive	ASD-A2-1021- □
<b>Low Inertia Servo Motor</b>	<b>ECMA-C △ 1010 □ S</b>
Power Cable (Without Brake)	ASD-CAPW100X
Power Cable (With Brake)	ASD-CAPW110X
Power Connector (With Brake)	ASD-CAPW1000
Incremental Encoder Cable	ASD-CAEN100X
Absolute Encoder Cable	ASD-A2EB100X
Encoder Connector	ASD-CAEN1000

(X=3 indicates cable length is 3m; X=5 indicates cable length is 5m)

### 1kW Servo Drive and 1kW Low Inertia Servo Motor

Servo Drive	ASD-A2-1021- □
<b>Low Inertia Servo Motor</b>	<b>ECMA-C △ 0910 □ S</b>
Power Cable (Without Brake)	ASD-ABPW000X
Power Cables (With Brake)	ASD-ABPW010X
Power Connector (Without Brake)	ASDBCAPW0000
Power Connector (With Brake)	ASDBCAPW0100
Incremental Encoder Cable	ASD-ABEN000X
Absolute Encoder Cable	ASD-A2EB000X
Encoder Connector	ASD-ABEN0000

(X=3 indicates cable length is 3m; X=5 indicates cable length is 5m)

### 1kW Servo Drive and 1kW Medium Servo Motor

Servo Drive	ASD-A2-1021- □
<b>Medium Servo Motor</b>	<b>ECMA-E △ 1310 □ S</b>
Power Cable (Without Brake)	ASD-CAPW100X
Power Cable (With Brake)	ASD-CAPW110X
Power Connector	ASD-CAPW1000
Incremental Encoder Cable	ASD-CAEN100X
Absolute Encoder Cable	ASD-A2EB100X
Encoder Connector	ASD-CAEN1000

(X=3 indicates cable length is 3m; X=5 indicates cable length is 5m)

# Servo Drive, Servo Motor and Accessories Combinations

## 220 V Series

### 1kW Servo Drive and 850W High Inertia Servo Motor

Servo Drive	ASD-A2-1021-□
<b>High Inertia Servo Motor</b>	<b>ECMA-F △ 1308 □ S</b>
Power Cable (Without Brake)	ASD-CAPW100X
Power Cable (With Brake)	ASD-CAPW110X
Power Connector	ASD-CAPW1000
Incremental Encoder Cable	ASD-CAEN100X
Absolute Encoder Cable	ASD-A2EB100X
Encoder Connector	ASD-CAEN1000

(X=3 indicates cable length is 3m; X=5 indicates cable length is 5m)

### 1kW Servo Drive and 900W High Inertia Servo Motor

Servo Drive	ASD-A2-1021-□
<b>High Inertia Servo Motor</b>	<b>ECMA-G △ 1309 □ S</b>
Power Cable (Without Brake)	ASD-CAPW100X
Power Cable (With Brake)	ASD-CAPW110X
Power Connector	ASD-CAPW1000
Incremental Encoder Cable	ASD-CAEN100X
Absolute Encoder Cable	ASD-A2EB100X
Encoder Connector	ASD-CAEN1000

(X=3 indicates cable length is 3m; X=5 indicates cable length is 5m)

### 1.5kW Servo Drive and 1.5kW Medium Servo Motor

Servo Drive	ASD-A2-1521-□
<b>Medium Servo Motor</b>	<b>ECMA-E △ 1315 □ S</b>
Power Cable (Without Brake)	ASD-CAPW100X
Power Cable (With Brake)	ASD-CAPW110X
Power Connector	ASD-CAPW1000
Incremental Encoder Cable	ASD-CAEN100X
Absolute Encoder Cable	ASD-A2EB100X
Encoder Connector	ASD-CAEN1000

(X=3 indicates cable length is 3m; X=5 indicates cable length is 5m)

### 2kW Servo Drive and 2kW Low Inertia Servo Motor

Servo Drive	ASD-A2-2023-□
<b>Low Inertia Servo Motor</b>	<b>ECMA-C △ 1020 □ S</b>
Power Cables (Without Brake)	ASD-A2PW100X
Power Cables (With Brake)	ASD-A2PW110X
Power Connector	ASD-CAPW1000
Incremental Encoder Cable	ASD-CAEN100X
Absolute Encoder Cable	ASD-A2EB100X
Encoder Connector	ASD-CAEN1000

(X=3 indicates cable length is 3m; X=5 indicates cable length is 5m)

### 2kW Servo Drive and 2kW Medium Servo Motor

Servo Drive	ASD-A2-2023-□
<b>Medium Servo Motor</b>	<b>ECMA-E △ 1320 □ S</b>
Power Cable (Without Brake)	ASD-A2PW100X
Power Cable (With Brake)	ASD-A2PW110X
Power Connector	ASD-CAPW1000
Incremental Encoder Cable	ASD-CAEN100X
Absolute Encoder Cable	ASD-A2EB100X
Encoder Connector	ASD-CAEN1000

(X=3 indicates cable length is 3m; X=5 indicates cable length is 5m)

### 2kW Servo Drive and 2kW Medium Servo Motor

Servo Drive	ASD-A2-2023-□
<b>Medium Servo Motor</b>	<b>ECMA-E △ 1820 □ S</b>
Power Cable (Without Brake)	ASD-CAPW200X
Power Cable (With Brake)	ASD-CAPW210X
Power Connector	ASD-CAPW2000
Incremental Encoder Cable	ASD-CAEN100X
Absolute Encoder Cable	ASD-A2EB100X
Encoder Connector	ASD-CAEN1000

(X=3 indicates cable length is 3m; X=5 indicates cable length is 5m)



### 2kW Servo Drive and 1.3kW Medium-High Inertia Servo Motor

Servo Drive	ASD-A2-2023- □
Medium-High Inertia Servo Motor	ECMA-F△1313 □ S
Power Cable (Without Brake)	ASD-A2PW100X
Power Cable (With Brake)	ASD-A2PW110X
Power Connector	ASD-CAPW1000
Incremental Encoder Cable	ASD-CAEN100X
Absolute Encoder Cable	ASD-A2EB100X
Encoder Connector	ASD-CAEN1000

(X=3 indicates cable length is 3m; X=5 indicates cable length is 5m)

### 2kW Servo Drive and 1.8kW Medium-High Inertia Servo Motor

Servo Drive	ASD-A2-2023- □
Medium-High Inertia Servo Motor	ECMA-F△1318 □ S
Power Cable (Without Brake)	ASD-A2PW100X
Power Cable (With Brake)	ASD-A2PW110X
Power Connector	ASD-CAPW1000
Incremental Encoder Cable	ASD-CAEN100X
Absolute Encoder Cable	ASD-A2EB100X
Encoder Connector	ASD-CAEN1000

(X=3 indicates cable length is 3m; X=5 indicates cable length is 5m)

### 3kW Servo Drive and 3kW Low Inertia Servo Motor

Servo Drive	ASD-A2-3023- □
Low Inertia Servo Motor	ECMA-C △ 1330 □ 4
Power Cable (Without Brake)	ASD-CAPW200X
Power Cable (With Brake)	ASD-CAPW210X
Power Connector	ASD-CAPW2000
Incremental Encoder Cable	ASD-CAEN100X
Absolute Encoder Cable	ASD-A2EB100X
Encoder Connector	ASD-CAEN1000

(X=3 indicates cable length is 3m; X=5 indicates cable length is 5m)

### 3kW Servo Drive and 3kW Medium Servo Motor

Servo Drive	ASD-A2-3023- □
Medium Servo Motor	ECMA-E △ 1830 □ S
Power Cable (Without Brake)	ASD-CAPW200X
Power Cable (With Brake)	ASD-CAPW210X
Power Connector	ASD-CAPW2000
Incremental Encoder Cable	ASD-CAEN100X
Absolute Encoder Cable	ASD-A2EB100X
Encoder Connector	ASD-CAEN1000

(X=3 indicates cable length is 3m; X=5 indicates cable length is 5m)

### 3kW Servo Drive and 3.5kW Medium-High Inertia Servo Motor

Servo Drive	ASD-A2-3023- □
Medium-High Inertia Servo Motor	ECMA-E △ 1835 □ S
Power Cable (Without Brake)	ASD-CAPW200X
Power Cable (With Brake)	ASD-CAPW210X
Power Connector	ASD-CAPW2000
Incremental Encoder Cable	ASD-CAEN100X
Absolute Encoder Cable	ASD-A2EB100X
Encoder Connector	ASD-CAEN1000

(X=3 indicates cable length is 3m; X=5 indicates cable length is 5m)

### 3kW Servo Drive and 3kW Medium-High Inertia Servo Motor

Servo Drive	ASD-A2-3023- □
Medium-High Inertia Servo Motor	ECMA-F △ 1830 □ S
Power Cable (Without Brake)	ASD-CAPW200X
Power Cable (With Brake)	ASD-CAPW210X
Power Connector	ASD-CAPW2000
Incremental Encoder Cable	ASD-CAEN100X
Absolute Encoder Cable	ASD-A2EB100X
Encoder Connector	ASD-CAEN1000

(X=3 indicates cable length is 3m; X=5 indicates cable length is 5m)

# Servo Drive, Servo Motor and Accessories Combinations

## 220 V Series

### 4.5kW Servo Drive and 4.5kW Medium-High Inertia Servo Motor

Servo Drive	ASD-A2-4523- □
Medium-High Inertia Servo Motor	ECMA-F △ 1845 □ S
Power Cable (Without Brake)	ASD-CAPW320X
Power Cable (With Brake)	ASD-CAPW330X
Power Connector	ASD-CAPW2000
Incremental Encoder Cable	ASD-CAEN100X
Absolute Encoder Cable	ASD-A2EB100X
Encoder Connector	ASD-CAEN1000

(X=3 indicates cable length is 3m; X=5 indicates cable length is 5m)

### 5.5kW Servo Drive and 5.5kW Medium-High Inertia Servo Motor

Servo Drive	ASD-A2-5523- □
Medium-High Inertia Servo Motor	ECMA-F △ 1855 □ 3
Power Cable (Without Brake)	ASD-CAPW450X
Power Cable (With Brake)	ASD-CAPW470X
Power Connector	ASD-CAPW4000
Brake Cable	ASD-CNBR1000
Incremental Encoder Cable	ASD-CAEN100X
Absolute Encoder Cable	ASD-A2EB100X
Encoder Connector	ASD-CAEN1000

(X=3 indicates cable length is 3m; X=5 indicates cable length is 5m)

### 7.5kW Servo Drive and 7.5kW Medium-High Inertia Servo Motor

Servo Drive	ASD-A2-7523- □
Medium-High Inertia Servo Motor	ECMA-F △ 1875 □ 3
Power Cable (Without Brake)	ASD-CAPW450X
Power Cable (With Brake)	ASD-CAPW470X
Power Connector	ASD-CAPW4000
Brake Cable	ASD-CNBR1000
Incremental Encoder Cable	ASD-CAEN100X
Absolute Encoder Cable	ASD-A2EB100X
Encoder Connector	ASD-CAEN1000

(X=3 indicates cable length is 3m; X=5 indicates cable length is 5m)

### 111kW Servo Drive and 111kW Medium-High Inertia Servo Motor

Servo Drive	ASD-A2-1B23- □
Medium-High Inertia Servo Motor	ECMA-F1221B □ 3
Power Cable (Without Brake)	ASD-CAPW450X
Power Cable (With Brake)	ASD-CAPW470X
Power Connector	ASD-CAPW4000
Brake Cable	ASD-CNBR1000
Incremental Encoder Cable	ASD-CAEN100X
Absolute Encoder Cable	ASD-A2EB100X
Encoder Connector	ASD-CAEN1000

(X=3 indicates cable length is 3m; X=5 indicates cable length is 5m)

### 15kW Servo Drive and 15kW Medium-High Inertia Servo Motor

Servo Drive	ASD-A2-1F23- □
Medium-High Inertia Servo Motor	ECMA-F1 221F □ S
Power Cable (Without Brake)	ASD-CAPW450X
Power Cable (With Brake)	ASD-CAPW470X
Power Connector	ASD-CAPW4000
Brake Cable	ASD-CNBR1000
Incremental Encoder Cable	ASD-CAEN100X
Absolute Encoder Cable	ASD-A2EB100X
Encoder Connector	ASD-CAEN1000

(X=3 indicates cable length is 3m; X=5 indicates cable length is 5m)

## 400V Series

### 750W Servo Drive and 400W Low Inertia Servo Motor

Servo Drive	ASD-A2-0743- □
Low Inertia Servo Motor	ECMA-J △ 0604 □ S
Power Cable (Without Brake)	ASD-CAPW540X
Power Connector (Without Brake)	ASD-CAPW5400
Power Cable (With Brake)	ASD-CAPW510X
Power Connector (With Brake)	ASD-CAPW5100
Incremental Encoder Cable	ASD-ABEN000X
Absolute Encoder Cable	ASD-A2EB000X
Encoder Connector	ASD-ABEN0000

(X=3 indicates cable length is 3m; X=5 indicates cable length is 5m)

### 750W Servo Drive and 750W Low Inertia Servo Motor

Servo Drive	ASD-A2-0743- □
Low Inertia Servo Motor	ECMA-J △ 0807 □ S
Power Cable (Without Brake)	ASD-CAPW540X
Power Connector (Without Brake)	ASD-CAPW5400
Power Cable (With Brake)	ASD-CAPW510X
Power Connector (With Brake)	ASD-CAPW5100
Incremental Encoder Cable	ASD-ABEN000X
Absolute Encoder Cable	ASD-A2EB000X
Encoder Connector	ASD-ABEN0000

(X=3 indicates cable length is 3m; X=5 indicates cable length is 5m)

### 750W Servo Drive and 750W Low Inertia Servo Motor

Servo Drive	ASD-A2-0743- □
Low Inertia Servo Motor	ECMA-J △ 0907 □ S
Power Cable (Without Brake)	ASD-CAPW540X
Power Connector (Without Brake)	ASD-CAPW5400
Power Cable (With Brake)	ASD-CAPW510X
Power Connectors (With Brake)	ASD-CAPW5100
Incremental Encoder Cable	ASD-ABEN000X
Absolute Encoder Cable	ASD-A2EB000X
Encoder Connector	ASD-ABEN0000

(X=3 indicates cable length is 3m; X=5 indicates cable length is 5m)

### 750W Servo Drive and 500W Medium Servo Motor

Servo Drive	ASD-A2-0743- □
Medium Servo Motor	ECMA-K △ 1305 □ S
Power Cable (Without Brake)	ASD-CAPW100X
Power Cable (With Brake)	ASD-CAPW110X
Power Connector	ASD-CAPW1000
Incremental Encoder Cable	ASD-CAEN100X
Absolute Encoder Cable	ASD-A2EB100X
Encoder Connector	ASD-CAEN1000

(X=3 indicates cable length is 3m; X=5 indicates cable length is 5m)

### 750W Servo Drive and 500W Medium-High Inertia Servo Motor

Servo Drive	ASD-A2-0743- □
Medium-High Inertia Servo Motor	ECMA-L △ 1305 □ S
Power Cable (Without Brake)	ASD-CAPW100X
Power Cable (With Brake)	ASD-CAPW110X
Power Connector	ASD-CAPW1000
Incremental Encoder Cable	ASD-CAEN100X
Absolute Encoder Cable	ASD-A2EB100X
Encoder Connector	ASD-CAEN1000

(X=3 indicates cable length is 3m; X=5 indicates cable length is 5m)

### 1kW Servo Drive and 850W High Inertia Servo Motor

Servo Drive	ASD-A2-1043- □
High Inertia Servo Motor	ECMA-L △ 1308 □ S
Power Cable (Without Brake)	ASD-CAPW100X
Power Cable (With Brake)	ASD-CAPW110X
Power Connector	ASD-CAPW1000
Incremental Encoder Cable	ASD-CAEN100X
Absolute Encoder Cable	ASD-A2EB100X
Encoder Connector	ASD-CAEN1000

(X=3 indicates cable length is 3m; X=5 indicates cable length is 5m)

# Servo Drive, Servo Motor and Accessories Combinations

## 400 V Series

### 1kW Servo Drive and 1kW Low Inertia Servo Motor

Servo Drive	ASD-A2-1043- □
<b>Low Inertia Servo Motor</b>	<b>ECMA-J △ 0910 □ S</b>
Power Cable (Without Brake)	ASD-CAPW540X
Power Connector (Without Brake)	ASD-CAPW5400
Power Cable (With Brake)	ASD-CAPW510X
Power Connector (With Brake)	ASD-CAPW5100
Incremental Encoder Cable	ASD-ABEN000X
Absolute Encoder Cable	ASD-A2EB000X
Encoder Connector	ASD-ABEN0000

(X=3 indicates cable length is 3m; X=5 indicates cable length is 5m)

### 1.5kW Servo Drive and 900W High Inertia Servo Motor

Servo Drive	ASD-A2-1543- □
<b>High Inertia Servo Motor</b>	<b>ECMA-M △ 1309 □ S</b>
Power Cable (Without Brake)	ASD-CAPW100X
Power Cable (With Brake)	ASD-CAPW110X
Power Connector	ASD-CAPW1000
Incremental Encoder Cable	ASD-CAEN100X
Absolute Encoder Cable	ASD-A2EB100X
Encoder Connector	ASD-CAEN1000

(X=3 indicates cable length is 3m; X=5 indicates cable length is 5m)

### 1kW Servo Drive and 1kW Medium Servo Motor

Servo Drive	ASD-A2-1043- □
<b>Medium Servo Motor</b>	<b>ECMA-K △ 1310 □ S</b>
Power Cable (Without Brake)	ASD-CAPW100X
Power Cable (With Brake)	ASD-CAPW110X
Power Connector	ASD-CAPW1000
Incremental Encoder Cable	ASD-CAEN100X
Absolute Encoder Cable	ASD-A2EB100X
Encoder Connector	ASD-CAEN1000

(X=3 indicates cable length is 3m; X=5 indicates cable length is 5m)

### 1.5kW Servo Drive and 1kW Low Inertia Servo Motor

Servo Drive	ASD-A2-1543- □
<b>Low Inertia Servo Motor</b>	<b>ECMA-J △ 1010 □ S</b>
Power Cable (Without Brake)	ASD-CAPW100X
Power Cable (With Brake)	ASD-CAPW110X
Power Connector	ASD-CAPW1000
Incremental Encoder Cable	ASD-CAEN100X
Absolute Encoder Cable	ASD-A2EB100X
Encoder Connector	ASD-CAEN1000

(X=3 indicates cable length is 3m; X=5 indicates cable length is 5m)

### 1.5kW Servo Drive and 1.3kW Medium-High Inertia Servo Motor

Servo Drive	ASD-A2-1543- □
<b>Medium-High Inertia Servo Motor</b>	<b>ECMA-L △ 1313 □ S</b>
Power Cable (Without Brake)	ASD-CAPW100X
Power Cable (With Brake)	ASD-CAPW110X
Power Connector	ASD-CAPW1000
Incremental Encoder Cable	ASD-CAEN100X
Absolute Encoder Cable	ASD-A2EB100X
Encoder Connector	ASD-CAEN1000

(X=3 indicates cable length is 3m; X=5 indicates cable length is 5m)

### 1.5kW Servo Drive and 1.5kW Medium Servo Motor

Servo Drive	ASD-A2-1543- □
<b>Medium Servo Motor</b>	<b>ECMA-K △ 1315 □ S</b>
Power Cable (Without Brake)	ASD-CAPW100X
Power Cable (With Brake)	ASD-CAPW110X
Power Connector	ASD-CAPW1000
Incremental Encoder Cable	ASD-CAEN100X
Absolute Encoder Cable	ASD-A2EB100X
Encoder Connector	ASD-CAEN1000

(X=3 indicates cable length is 3m; X=5 indicates cable length is 5m)

### 2kW Servo Drive and 2kW Low Inertia Servo Motor

Servo Drive	ASD-A2-2043- □
<b>Low Inertia Servo Motor</b>	<b>ECMA-J △ 1020 □ S</b>
Power Cable (Without Brake)	ASD-CAPW120X
Power Cable (With Brake)	ASD-CAPW130X
Power Connector	ASD-CAPW1000
Incremental Encoder Cable	ASD-CAEN100X
Absolute Encoder Cable	ASD-A2EB100X
Encoder Connector	ASD-CAEN1000

(X=3 indicates cable length is 3m; X=5 indicates cable length is 5m)

### 2kW Servo Drive and 2kW Medium-High Inertia Servo Motor

Servo Drive	ASD-A2-2043- □
<b>Medium Servo Motor</b>	<b>ECMA-K △ 1320 □ S</b>
Power Cable (Without Brake)	ASD-CAPW120X
Power Cable (With Brake)	ASD-CAPW130X
Power Connector	ASD-CAPW1000
Incremental Encoder Cable	ASD-CAEN100X
Absolute Encoder Cable	ASD-A2EB100X
Encoder Connector	ASD-CAEN1000

(X=3 indicates cable length is 3m; X=5 indicates cable length is 5m)

### 2kW Servo Drive and 2kW Medium Servo Motor

Servo Drive	ASD-A2-2043- □
<b>Medium Servo Motor</b>	<b>ECMA-K △ 1820 □ S</b>
Power Cable (Without Brake)	ASD-CAPW220X
Power Cable (With Brake)	ASD-CAPW230X
Power Connector	ASD-CAPW2000
Incremental Encoder Cable	ASD-CAEN100X
Absolute Encoder Cable	ASD-A2EB100X
Encoder Connector	ASD-CAEN1000

(X=3 indicates cable length is 3m; X=5 indicates cable length is 5m)

### 3kW Servo Drive and 3kW Low Inertia Servo Motor

Servo Drive	ASD-A2-3043- □
<b>Low Inertia Servo Motor</b>	<b>ECMA-J △ 1330 □ 4</b>
Power Cable (Without Brake)	ASD-CAPW120X
Power Cable (With Brake)	ASD-CAPW130X
Power Connector	ASD-CAPW1000
Incremental Encoder Cable	ASD-CAEN100X
Absolute Encoder Cable	ASD-A2EB100X
Encoder Connector	ASD-CAEN1000

(X=3 indicates cable length is 3m; X=5 indicates cable length is 5m)

### 3kW Servo Drive and 3kW Medium-High Inertia Servo Motor

Servo Drive	ASD-A2-3043- □
<b>Medium-High Inertia Servo Motor</b>	<b>ECMA-L △ 1830 □ S</b>
Power Cable (Without Brake)	ASD-CAPW220X
Power Cable (With Brake)	ASD-CAPW230X
Power Connector	ASD-CAPW2000
Incremental Encoder Cable	ASD-CAEN100X
Absolute Encoder Cable	ASD-A2EB100X
Encoder Connector	ASD-CAEN1000

(X=3 indicates cable length is 3m; X=5 indicates cable length is 5m)

### 4.5kW Servo Drive and 4.5kW Medium-High Inertia Servo Motor

Servo Drive	ASD-A2-4543- □
<b>Medium-High Inertia Servo Motor</b>	<b>ECMA-L △ 1845 □ S</b>
Power Cable (Without Brake)	ASD-CAPW220X
Power Cable (With Brake)	ASD-CAPW230X
Power Connector	ASD-CAPW2000
Incremental Encoder Cable	ASD-CAEN100X
Absolute Encoder Cable	ASD-A2EB100X
Encoder Connector	ASD-CAEN1000

(X=3 indicates cable length is 3m; X=5 indicates cable length is 5m)

# Servo Drive, Servo Motor and Accessories Combinations

## 400 V Series

### 5.5kW Servo Drive and 5.5kW Medium-High Inertia Servo Motor

Servo Drive	ASD-A2-5543-□
<b>Medium-High Inertia Servo Motor</b>	<b>ECMA-L △ 1855 □ 3</b>
Power Cable (Without Brake)	ASD-CAPW220X
Power Cable (With Brake)	ASD-CAPW230X
Power Connector	ASD-CAPW2000
Incremental Encoder Cable	ASD-CAEN100X
Absolute Encoder Cable	ASD-A2EB100X
Encoder Connector	ASD-CAEN1000

(X=3 indicates cable length is 3m; X=5 indicates cable length is 5m)

### 7.5kW Servo Drive and 7.5kW Medium-High Inertia Servo Motor

Servo Drive	ASD-A2-7543-□
<b>Medium-High Inertia Servo Motor</b>	<b>ECMA-L △ 1875 □ 3</b>
Power Cable (Without Brake)	ASD-CAPW320X
Power Cable (With Brake)	ASD-CAPW330X
Power Connector	ASD-CAPW2000
Incremental Encoder Cable	ASD-CAEN100X
Absolute Encoder Cable	ASD-A2EB100X
Encoder Connector	ASD-CAEN1000

(X=3 indicates cable length is 3m; X=5 indicates cable length is 5m)

11kW and 15kW models will be available soon  
For the available models and related optional accessories, please visit our website at: [www.deltaww.com](http://www.deltaww.com), or please consult our local distributors.

### 11kW Servo Drive and 11kW Medium-High Inertia Servo Motor

Servo Drive	ASD-A2-1B43-□
<b>Medium-High Inertia Servo Motor</b>	<b>ECMA-L1221B □ 3</b>
Power Cable (Without Brake)	ASD-CAPW450X
Power Cable (With Brake)	ASD-CAPW470X
Power Connector	ASD-CAPW4000
Brake Connector	ASD-CNBR1000
Incremental Encoder Cable	ASD-CAEN100X
Absolute Encoder Cable	ASD-A2EB100X
Encoder Connector	ASD-CAEN1000

(X=3 indicates cable length is 3m; X=5 indicates cable length is 5m)

11kW and 15kW models will be available soon  
For the available models and related optional accessories, please visit our website at: [www.deltaww.com](http://www.deltaww.com), or please consult our local distributors.

### 15kW Servo Drive and 15kW Medium-High Inertia Servo Motor

Servo Drive	ASD-A2-1F43-□
<b>Medium-High Inertia Servo Motor</b>	<b>ECMA-L1221F □ S</b>
Power Cable (Without Brake)	ASD-CAPW460X
Power Cable (With Brake)	ASD-CAPW480X
Power Connector	ASD-CAPW4000
Brake Connector	ASD-CNBR1000
Incremental Encoder Cable	ASD-CAEN100X
Absolute Encoder Cable	ASD-A2EB100X
Encoder Connector	ASD-CAEN1000

(X=3 indicates cable length is 3m; X=5 indicates cable length is 5m)

## Safety Information

<b>Global Standards</b>	ASDA-A2 series is designed to fully comply with demanding international standards, such as IEC, EN and others, for all fields of industrial automation technology.
<b>EMC Standards</b>	EN61000-4-6 Level 3
	EN61000-4-3 Level 3
	EN61000-4-2 Level 2 and Level 3
	EN61000-4-4 Level 3
	EN61000-4-8 Level 4
	EN61000-4-5 Level 3
<b>Conducted &amp; Radiated Emissions</b>	Complies with EN550011 Class A Group 1, with external EMC filter
<b>CE Marking</b>	CE recognized. Complies with Directive 2006/95/EC of the European Parliament and EMC Directive 2004/108/EC.
<b>UL Approval</b>	UL (U.S.), cUL (Canada) recognized.
<b>Test Standard</b>	IEC/EN50178, IEC/EN60529 IP20
<b>Vibration</b>	1G less than 20Hz, 0.6G 20 to 50Hz. Complies with IEC/EN50178
<b>Shock</b>	15gn 11ms. Complies with IEC/EN600028-2-27
<b>Pollution Degree</b>	Degree 2. Complies with IEC/EN61800-5-1

# Other Accessories

(for ASDA-A2 series all models)

Description	Delta Part Number
50-Pin I/O Connector (CN1)	ASD-CN5C0050
Terminal Block Module	ASD-BM-50A
RS-232 Communication Cable	ASD-CARS0003
Communication Cable between Drive and Computer (for PC)	DOP-CAUSBAB
CANopen Communication Cable	TAP-CB03 / TAP-CB05
CANopen Distribution Box	TAP-CN03
RS-485 Connector	ASD-CNIE0B06
Regenerative Resistor 400W 40Ω	BR400W040
Regenerative Resistor 1kW 20Ω	BR1K0W020
Regenerative Resistor 1.5kW 5Ω	BR1K5W005

# Regenerative Resistor Specifications

## 220V Series

Servo Drive (kW)	Specifications of Built-in Regenerative Resistors		Min. Allowable Resistance (Ohm)
	Resistance (parameter P1-52) (Ohm)	Capacity (parameter P1-53) (Watt)	
0.1	-	-	30 Ω
0.2	-	-	30 Ω
0.4	40 Ω	40 W	30 Ω
0.75	40 Ω	60 W	20 Ω
1.0	40 Ω	60 W	20 Ω
1.5	40 Ω	60 W	20 Ω
2.0	20 Ω	100 W	10 Ω
3.0	20 Ω	100 W	10 Ω
4.5	20 Ω	100 W	10 Ω
5.5	-	-	8 Ω
7.5	-	-	8 Ω
11	-	-	8 Ω
15	-	-	5 Ω

**Footnote:**

- 400W ~ 4.5kW servo drives provide a built-in regenerative resistor.
- When the fault, ALE05 (Regeneration Error) occurs, please increase the regenerative resistor capacity or decrease the regenerative resistor resistance (the regenerative resistor resistance should not be less than the minimum allowable resistance listed in the above table.)
- If the situation is not improved after increasing the regenerative resistor capacity or decreasing the regenerative resistor resistance, please purchase a regenerative resistor module.
- When combining multiple small-capacity regenerative resistors in parallel to increase the regenerative resistor capacity, make sure that the total resistance value of the regenerative resistors is not less than the minimum allowable resistance listed in the above table.

## 400V Series

Servo Drive (kW)	Specifications of Built-in Regenerative Resistors		Min. Allowable Resistance (Ohm)
	Resistance (parameter P1-52) (Ohm)	Capacity (parameter P1-53) (Watt)	
0.4	80 Ω	100W	60 Ω
0.75	80 Ω	100W	60 Ω
1.0	80 Ω	100W	60 Ω
1.5	80 Ω	100W	40 Ω
2.0	-	-	40 Ω
3.0	-	-	30 Ω
4.5	-	-	20 Ω
5.5	-	-	20 Ω
7.5	-	-	15 Ω
11	-	-	15 Ω
15	-	-	10 Ω

**Footnote:**

- 750W ~ 1.5kW servo drives provide a built-in regenerative resistor.
- When the fault, ALE05 (Regeneration Error) occurs, please increase the regenerative resistor capacity or decrease the regenerative resistor resistance (the regenerative resistor resistance should not be less than the minimum allowable resistance listed in the above table.)
- If the situation is not improved after increasing the regenerative resistor capacity or decreasing the regenerative resistor resistance, please purchase a regenerative resistor module.
- When combining multiple small-capacity regenerative resistors in parallel to increase the regenerative resistor capacity, make sure that the total resistance value of the regenerative resistors is not less than the minimum allowable resistance listed in the above table.





# mairsa

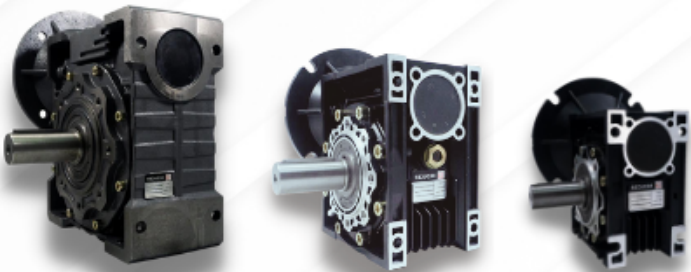

[contacto@mairsa.com.mx](mailto:contacto@mairsa.com.mx)

[www.motorreductores.mx](http://www.motorreductores.mx)

[www.mairsa.com.mx](http://www.mairsa.com.mx)



**SUCURSAL EN SINALOA:**  
Bvd. Emiliano Zapata 2220 Pte.  
Col. Vallado Nuevo  
C.P. 80110  
Culiacán, Sinaloa  
(667) 714-22-03 y (667) 713-22-03



**SUCURSAL EN JALISCO:**  
Av. Washington 1576  
Col. Moderna.  
C.P. 44190  
Guadalajara, Jalisco  
(33) 38-10-49-96 y (33) 14-78-84-15



**SUCURSAL EN HERMOSILLO:**  
Calle Suaqui #35-A  
Col. Pimentel  
C.P. 83188  
Hermosillo, Sonora  
(66)2210-2229



**SUCURSAL EN MONTERREY:**  
Av. Dr. Jose Eleuterio Gonzalez 914 L-1  
Col. Leones  
C.P. 64600  
Monterrey, Nuevo Leon  
(81) 31-84-94-44 y (81) 17-64-22-08