

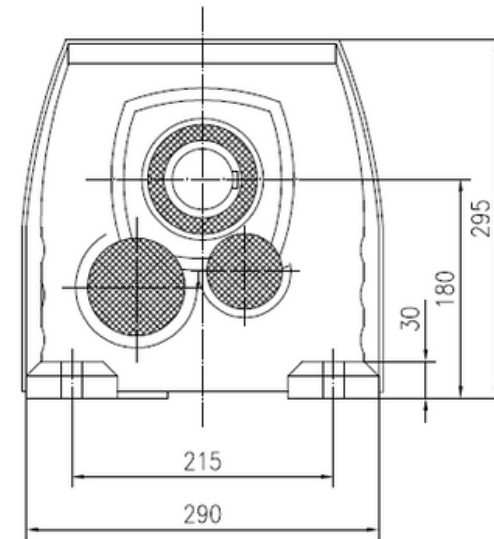

# R88-32-210TC

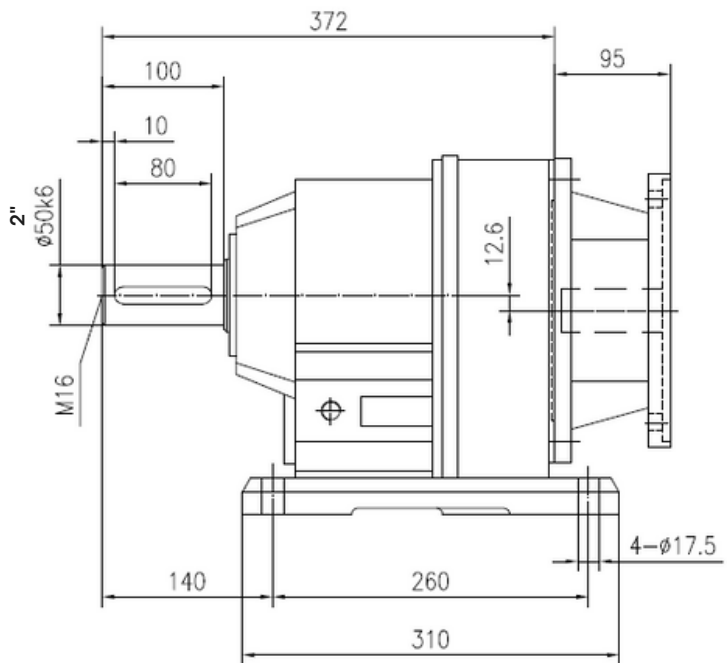

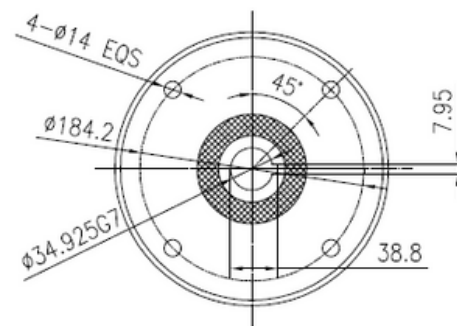
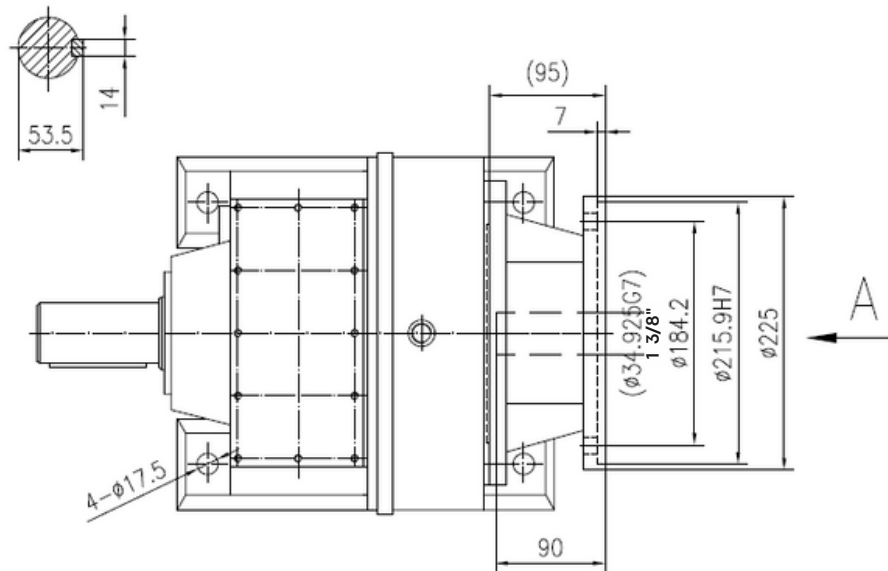

A Side



[www.motorreductores.mx](http://www.motorreductores.mx)  
[www.mairsa.com.mx](http://www.mairsa.com.mx)  
[contacto@mairsa.com.mx](mailto:contacto@mairsa.com.mx)

 (33) 38-10-49-96  
 (33) 35-93-32-88

 /mairsa1  
 /mairsa\_eagle  
 /mairsa

